



# Digi XBee3<sup>®</sup> Cellular LTE-M/NB-IoT

Smart Modem

---

User Guide

## Revision history—90002258

---

Revision	Date	Description
D	August 2018	<ul style="list-style-type: none"><li>■ Updated list of cipher suites</li><li>■ Updated Get Started section.</li><li>■ Updated <a href="#">Electrical specifications</a>.</li><li>■ Updated <a href="#">Socket leaks</a> section.</li><li>■ Updated UDP bytes limit in the <a href="#">Transmit (TX) Request: IPv4 - 0x20</a> section.</li><li>■ Updated <a href="#">cellular chipset</a> information.</li><li>■ Removed SMS information.</li></ul>
E	September 2018	Added information for NB-IoT
F	November 2018	Added information for BLE
G	February 2019	Added information for <a href="#">XBIB-C-TH</a> and <a href="#">XBIB-C-GPS</a> development boards
H	April 2019	Added information for Digi Remote Manager®
	May 2019	Added information for <a href="#">Clean shutdown</a> and <a href="#">securing the connection</a> between and XBee and Remote Manager.

## Trademarks and copyright

Digi, Digi International, and the Digi logo are trademarks or registered trademarks in the United States and other countries worldwide. All other trademarks mentioned in this document are the property of their respective owners.

© 2019 Digi International Inc. All rights reserved.

## Disclaimers

Information in this document is subject to change without notice and does not represent a commitment on the part of Digi International. Digi provides this document “as is,” without warranty of any kind, expressed or implied, including, but not limited to, the implied warranties of fitness or merchantability for a particular purpose. Digi may make improvements and/or changes in this manual or in the product(s) and/or the program(s) described in this manual at any time.

## Warranty

To view product warranty information, go to the following website:

[www.digi.com/howtobuy/terms](http://www.digi.com/howtobuy/terms)

## Customer support

**Gather support information:** Before contacting Digi technical support for help, gather the following information:

- Product name and model
- Product serial number (s)
- Firmware version
- Operating system/browser (if applicable)
- Logs (from time of reported issue)
- Trace (if possible)
- Description of issue
- Steps to reproduce

**Contact Digi technical support:** Digi offers multiple technical support plans and service packages. Contact us at +1 952.912.3444 or visit us at [www.digi.com/support](http://www.digi.com/support).

## Feedback

To provide feedback on this document, email your comments to

[techcomm@digi.com](mailto:techcomm@digi.com)

Include the document title and part number (Digi XBee3 Cellular LTE-M/NB-IoT Global Smart Modem User Guide, 90002258 C) in the subject line of your email.

# Contents

---

## Digi XBee3 Cellular LTE-M/NB-IoT Global Smart Modem User Guide

Applicable firmware and hardware .....	15
SIM cards .....	15
NB-IoT network .....	15

## Get started with the XBee Smart Modem Development Kit

Identify the kit contents .....	17
Acquire a SIM card .....	18
US customers .....	18
European customers .....	18
Connect the hardware .....	19
XBIB-U-DEV reference .....	21
XBIB-CU-TH reference .....	23
XBIB-C-GPS reference .....	26
Interface with the XBIB-C-GPS module .....	27
I2C communication .....	28
UART communication .....	28
Run the MicroPython GPS demo .....	28
Cellular service .....	29
Configure the device using XCTU .....	30
Before you begin .....	30
Add a device .....	30
Update to the latest firmware from XCTU .....	30
Configure module for NB-IoT .....	31
Check for cellular registration and connection .....	32
XBee bootloader .....	33

## XBee connection examples

Connect to the Echo server .....	35
Connect to the ELIZA server .....	37
Connect to the Daytime server .....	39
Perform a (GET) HTTP request .....	41
Get started with CoAP .....	43
CoAP terms .....	43
CoAP quick start example .....	43
Configure the device .....	44
Example: manually perform a CoAP request .....	44
Example: use Python to generate a CoAP message .....	45

Connect to a TCP/IP address .....	47
Get started with MQTT .....	48
Example: MQTT connect .....	48
Send a connect packet .....	50
Example: send messages (publish) with MQTT .....	51
Example: receive messages (subscribe) with MQTT .....	52
Use MQTT over the XBee Cellular Modem with a PC .....	53
Debugging .....	56
Software libraries .....	56

## Get started with MicroPython

About MicroPython .....	58
Why use MicroPython .....	58
MicroPython on the XBee Smart Modem .....	58
Use XCTU to enter the MicroPython environment .....	58
Use the MicroPython Terminal in XCTU .....	59
Troubleshooting .....	59
Example: hello world .....	59
Example: turn on an LED .....	59
Example: debug the secondary UART .....	60
Exit MicroPython mode .....	61
Other terminal programs .....	61
Tera Term for Windows .....	62
Use picocom in Linux .....	63

## Get started with BLE

Enable BLE on an XBee device .....	65
Enable BLE and configure the BLE password using XCTU .....	65
Get the Digi XBee Mobile phone application .....	66
Connect with BLE and configure your XBee device .....	67
BLE reference .....	67
BLE advertising behavior and services .....	67
Device Information Service .....	67
XBee API BLE Service .....	68
API Request characteristic .....	68
API Response characteristic .....	68

## Get started with Digi Remote Manager

Create a Remote Manager account and add devices .....	70
Create a Remote Manager account .....	71
Add an XBee Smart Modem to Remote Manager .....	71
Verify the connection between a device and Remote Manager .....	72
Configure Remote Manager features by scheduling tasks .....	72
Overview: Create a schedule for a set of tasks .....	73
Examples .....	73
Example: Read settings and state using Remote Manager .....	73
Example: Configure a device from Remote Manager using XML .....	74
Example: Update XBee firmware using Remote Manager .....	75
Example: Update MicroPython from Remote Manager using XML .....	76
Restore persistent connection to a remote XBee .....	80

Manage data in Remote Manager .....	81
Review device status information from Remote Manager .....	82
Update the firmware from Remote Manager .....	82
Update the firmware using web services in Remote Manager .....	84
Manage secure files in Remote Manager .....	87
Remote Manager reference .....	88
Enable SM/UDP .....	88
Disconnect .....	89
Configure XBee settings within Remote Manager .....	89

## Technical specifications

Interface and hardware specifications .....	93
Cellular RF characteristics .....	93
Bluetooth RF characteristics .....	93
Cellular networking specifications .....	93
Power requirements .....	94
Power consumption .....	95
Electrical specifications .....	96
Regulatory approvals .....	97

## Hardware

Mechanical drawings .....	99
Pin signals .....	99
Pin connection recommendations .....	100
RSSI PWM .....	101
SIM card .....	101
Associate LED functionality .....	101

## Antenna recommendations

Antenna placement .....	104
-------------------------	-----

## Design recommendations

Cellular component firmware updates .....	106
Power supply considerations .....	106
Minimum connection diagram .....	106
Heat considerations and testing .....	107
Custom configuration: Create a new factory default .....	107
Set a custom configuration .....	108
Clear all custom configurations on a device .....	108
Clean shutdown .....	108
Sleep feature .....	108
Airplane mode .....	109

## Cellular connection process

Connecting .....	111
Cellular network .....	111
Data network connection .....	111

Data communication with remote servers (TCP/UDP) .....	111
Disconnecting .....	112

## Modes

Select an operating mode .....	114
Transparent operating mode .....	115
API operating mode .....	115
Command mode .....	115
Enter Command mode .....	115
Troubleshooting .....	116
Send AT commands .....	116
Response to AT commands .....	116
Apply command changes .....	117
Make command changes permanent .....	117
Exit Command mode .....	117
MicroPython mode .....	117
USB direct mode .....	118
Configure the data pins .....	118
Enable USB direct mode .....	118
Bypass operating mode (DEPRECATED) .....	118
Enter Bypass operating mode .....	119
Leave Bypass operating mode .....	119
Restore cellular settings to default in Bypass operating mode .....	119

## Sleep modes

About sleep modes .....	121
Normal mode .....	121
Pin sleep mode .....	121
Cyclic sleep mode .....	121
Cyclic sleep with pin wake up mode .....	121
SPI mode and sleep pin functionality .....	121
The sleep timer .....	122
MicroPython sleep behavior .....	122

## Power saving features

Airplane mode .....	124
Power Saving Mode (PSM) .....	124
PSM behavior .....	124
Deep Sleep mode .....	124

## Serial communication

Serial interface .....	127
Serial data .....	127
UART data flow .....	127
Serial buffers .....	128
CTS flow control .....	128
RTS flow control .....	128
Enable UART or SPI ports .....	128
I2C .....	129

## SPI operation

SPI communications .....	131
Full duplex operation .....	132
Low power operation .....	133
Select the SPI port .....	133
Force UART operation .....	134
Data format .....	134

## File system

Overview of the file system .....	136
Directory structure .....	136
Paths .....	136
Secure files .....	136
XCTU interface .....	137
Encrypt files .....	137

## Socket behavior

Supported sockets .....	139
Best practices when using sockets .....	139
Sockets and Remote Manager .....	139
Sockets and API mode .....	139
Socket timeouts .....	139
Socket limits in API mode .....	140
Enable incoming TCP sockets in API mode .....	140
API mode behavior for outgoing TCP and SSL connections .....	140
API mode behavior for outgoing UDP data .....	141
API mode behavior for incoming TCP connections .....	141
API mode behavior for incoming UDP data .....	142
Transparent mode behavior for outgoing TCP and SSL connections .....	142
Transparent mode behavior for outgoing UDP data .....	143
Transparent mode behavior for incoming TCP connections .....	143
Transparent mode behavior for incoming UDP connections .....	143

## Transport Layer Security (TLS)

TLS AT commands .....	145
Transparent mode and TLS .....	146
API mode and TLS .....	146
Key formats .....	146
Certificate formats .....	146
Certificate limitations .....	146
Cipher suites .....	147
Server Name Indication (SNI) .....	147
Secure the connection between an XBee and Remote Manager with server authentication .....	147
Step 1: Get the certificate .....	148
Step 2: Configure device .....	148
Step 3: Verify that authentication is being performed .....	148



## AT commands

Special commands	151
AC (Apply Changes)	151
FR (Force Reset)	151
RE (Restore Defaults)	151
WR (Write)	151
Cellular commands	153
PH (Phone Number)	153
S# (ICCID)	153
IM (IMEI)	153
MN (Operator)	153
MV (Modem Firmware Version)	153
DB (Cellular Signal Strength)	154
AN (Access Point Name)	154
CP (Carrier Profile)	154
BM (Bandmask) (LTE-M)	155
BN (Bandmask) (NB-IoT)	155
AM (Airplane Mode)	156
N# (Preferred Network Technology)	156
Network commands	158
IP (IP Protocol)	158
TL (SSL/TLS Protocol Version)	158
\$0 (SSL/TLS Profile 0)	159
\$1 (SSL/TLS Profile 1)	159
\$2 (SSL/TLS Profile 2)	159
TM (IP Client Connection Timeout)	160
TS (IP Server Connection Timeout)	160
DO (Device Options)	160
DT (Cellular Network Time)	161
Addressing commands	162
SH (Serial Number High)	162
SL (Serial Number Low)	162
MY (Module IP Address)	162
P# (Destination Phone Number)	162
N1 (DNS Address)	163
N2 (DNS Address)	163
DL (Destination Address)	163
OD (Operating Destination Address)	163
DE (Destination port)	164
C0 (Source Port)	164
LA (Lookup IP Address of FQDN)	164
Serial interfacing commands	165
BD (Baud Rate)	165
NB (Parity)	165
SB (Stop Bits)	166
RO (Packetization Timeout)	166
TD (Text Delimiter)	166
FT (Flow Control Threshold)	166
AP (API Enable)	167
I/O settings commands	168
D0 (DIO0/AD0)	168
D1 (DIO1/AD1)	168
D2 (DIO2/AD2)	169
D3 (DIO3/AD3)	169

D4 (DIO4)	169
D5 (DIO5/ASSOCIATED_INDICATOR)	170
D6 (DIO6/RTS)	170
D7 (DIO7/CTS)	170
D8 (DIO8/SLEEP_REQUEST)	171
D9 (DIO9/ON_SLEEP)	171
P0 (DIO10/PWM0 Configuration)	172
P1 (DIO11/PWM1 Configuration)	172
P2 (DIO12 Configuration)	173
P3 (DIO13/DOUT)	173
P4 (DIO14/DIN)	174
PD (Pull Direction)	174
PR (Pull-up/down Resistor Enable)	174
M0 (PWM0 Duty Cycle)	175
I/O sampling commands	176
TP (Temperature)	176
IS (Force Sample)	176
Sleep commands	178
SM (Sleep Mode)	178
SP (Sleep Period)	178
ST (Wake Time)	178
PA (Requested Active Timer)	179
PU (Requested Tracking Area Update Timer)	179
Command mode options	180
CC (Command Sequence Character)	180
CT (Command Mode Timeout)	180
CN (Exit Command mode)	180
GT (Guard Times)	180
MicroPython commands	182
PS (Python Startup)	182
PY (MicroPython Command)	182
Firmware version/information commands	184
VR (Firmware Version)	184
VL (Verbose Firmware Version)	184
HV (Hardware Version)	184
AI (Association Indication)	184
HS (Hardware Series)	185
CK (Configuration CRC)	185
Diagnostic interface commands	186
DI (Remote Manager Indicator)	186
CI (Protocol/Connection Indication)	186
AS (Active scan for network environment data)	188
Execution commands	189
NR (Network Reset)	189
!R (Modem Reset)	189
File system commands	190
Error responses	190
ATFS (File System)	190
ATFS PWD	190
ATFS CD directory	190
ATFS MD directory	190
ATFS LS [directory]	190
ATFS PUT filename	191
ATFS XPUT filename	191
ATFS HASH filename	191

ATFS GET filename .....	191
ATFS MV source_path dest_path .....	191
ATFS RM file_or_directory .....	191
ATFS INFO .....	191
ATFS FORMAT confirm .....	192
BLE commands .....	193
BL (Bluetooth MAC address) .....	193
BT (Bluetooth enable) .....	193
\$\$ (SRP Salt) .....	193
\$V, \$W, \$X, \$Y (SRP password verifier) .....	194
Remote Manager commands .....	195
DF (Remote Manager Status Check Interval) .....	195
EQ (Remote Manager FQDN) .....	195
K1 (Remote Manager Server Send Keepalive) .....	195
K2 (Remote Manager Device Send Keepalive) .....	195
MO (Remote Manager Options) .....	196
\$D (Remote Manager certificate) .....	196
RI (Remote Manager Service ID) .....	196
DP (Remote Manager Phone Number) .....	197
HF (Health Metrics Reporting Frequency) .....	197
HM (Health Metrics) .....	197
System commands .....	198
KL (Device Location) .....	198
KP (Device Description) .....	198
KC (Contact Information) .....	198

## Operate in API mode

API mode overview .....	200
Use the AP command to set the operation mode .....	200
API frame format .....	200
API operation (AP parameter = 1) .....	200
API operation with escaped characters (AP parameter = 2) .....	201

## API frames

AT Command - 0x08 .....	205
AT Command: Queue Parameter Value - 0x09 .....	206
Transmit (TX) SMS - 0x1F .....	207
Transmit (TX) Request: IPv4 - 0x20 .....	208
Tx Request with TLS Profile - 0x23 .....	210
AT Command Response - 0x88 .....	212
Transmit (TX) Status - 0x89 .....	213
Modem Status - 0x8A .....	215
Receive (RX) Packet: SMS - 0x9F .....	216
Receive (RX) Packet: IPv4 - 0xB0 .....	217
User Data Relay - 0x2D .....	218
Example use cases .....	218
User Data Relay Output - 0xAD .....	220
BLE Unlock API - 0x2C .....	221
Example sequence to perform AT Command XBee API frames over BLE .....	223
BLE Unlock Response - 0xAC .....	225

## Packaged firmware updates

About packaged firmware updates .....	227
Module firmware update .....	227
Cellular component firmware update .....	227
Packaged firmware update .....	227
FW Update - 0x2B .....	228
FW Update Response - 0xAB .....	228
Important notes .....	229
Perform a cellular component firmware update .....	229
Error recovery .....	230
Corrupted firmware on the cellular component .....	230
Error .....	230
Host initiated cancellation .....	230

## Troubleshooting

Cannot find the serial port for the device .....	232
Condition .....	232
Solution .....	232
Other possible issues .....	233
Enable Virtual COM port (VCP) on the driver .....	233
Correct a macOS Java error .....	234
Condition .....	234
Solution .....	234
Unresponsive cellular component in Bypass mode .....	235
Condition .....	235
Solution .....	235
Syntax error at line 1 .....	235
Solution .....	235
Error Failed to send SMS .....	235
Solution .....	235
Network connection issues .....	236
Condition .....	236
Solution .....	236
Brownout issue .....	236
Voltage brownout .....	236
Power-on discontinuities .....	236
How to distinguish revision B parts .....	236
Hardware flow control in Bypass mode .....	237
Socket leaks .....	237
Condition .....	237
Solution .....	238

## Regulatory information

United States (FCC) .....	240
OEM labeling requirements .....	240
FCC notices .....	240
FCC-approved antennas .....	241
RF exposure .....	241
Innovation, Science and Economic Development Canada (ISED) .....	242
Labeling requirements .....	242
RF Exposure .....	242

CE mark (Europe) .....243

# Digi XBee3 Cellular LTE-M/NB-IoT Global Smart Modem User Guide

---

The XBee Smart Modem provides OEMs with a simple way to integrate low-power cellular connectivity into their devices.

Features include:

- FCC certified and carrier end-device certified
- Excellent coverage and building penetration
- Manage and configure with XCTU and Digi Remote Manager®
- Available with Digi provided SIM cards and data plans
  
- Digital I/O support
- Analog input support
- [API](#) and [Transparent](#) mode
- Command mode
- [Bypass](#) to the raw cellular modem
- SMS: Some carriers do not support SMS on LTE-M and/or NB-IoT. Check with your carrier for details.
- [TCP/UDP](#) (up to six sockets)
- [TLS](#) (up to six sockets)
- [Incoming connections](#)
- [MicroPython](#)
  - On-module programmability to add local intelligence
  - Many examples in the [Digi MicroPython Programming Guide](#)
  - AT commands for managing run-time behavior
- [Low power modes](#)
- [LTE power save mode](#) (PSM)
- [Deep sleep mode](#)
- [Pin sleep support](#)
- [Cyclic sleep support](#)
- [Airplane mode support](#)
- [Digi TrustFence](#) secure boot
- Multi-network capability (Verizon, AT&T)

## Applicable firmware and hardware

This manual supports the following firmware:

- 114xx

It supports the following hardware:

- XB3-C-A2-UT-xxx

## SIM cards

The XBee Smart Modem requires a 4FF (Nano) size SIM card. The SIM interface supports both 1.8 V and 3 V SIM types.

## NB-IoT network

NB-IoT network is supported by XBee3 Cellular. Note the following:

- NB-IoT does not support roaming. You cannot roam between networks.
- For NB-IoT, TCP support is dependent on the network. Contact your network provider for details.
- For NB-IoT, SMS support is dependent on the network. Contact your network provider for details.
- Digi Remote Manager® requires TCP and will not work with NB-IoT unless the network supports TCP.
- The SIM card in the device determines whether the device supports NB-IoT, LTE-M, or both.

## Get started with the XBee Smart Modem Development Kit

---

This section describes how to connect the hardware in the XBee Smart Modem Development Kit, and provides some examples you can use to communicate with the device.

You should perform all of the steps below in the order shown.

1. [Identify the kit contents](#)
2. [Acquire a SIM card](#)
3. [Connect the hardware](#)
4. [Review the development board](#)
5. [Set up cellular service](#)
6. [Configure the device using XCTU](#)
7. Use one of the following methods to verify your cellular connection:
  - [Connect to the Echo server](#)
  - [Connect to the ELIZA server](#)
  - [Connect to the Daytime server](#)

### Optional steps

You can review the information in these steps for more XBee connection examples and examples of how to use MicroPython.

1. Review additional connection examples to help you learn how to use the device. See [XBee connection examples](#).
2. Review introductory MicroPython examples. You can use MicroPython to enhance the intelligence of the XBee to enable you to do edge-computing by adding business logic in MicroPython, rather than using external components.
  - [Example: hello world](#)
  - [Example: turn on an LED](#)



## Identify the kit contents

The Developer's kit includes the following:

One XBIB-U-DEV board

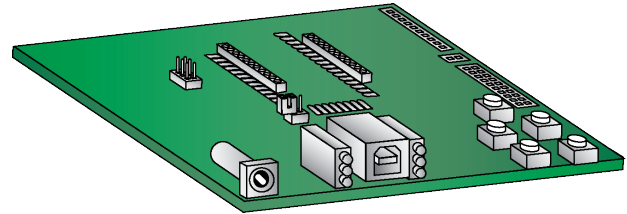

One 12 V power supply

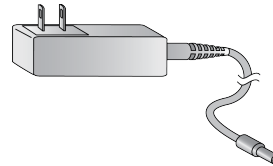

One cellular antenna with U.FL connector

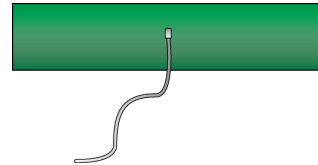

One Bluetooth Low Energy (BLE) antenna

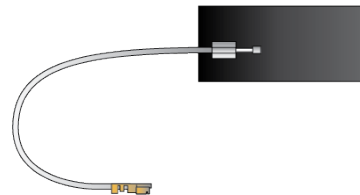

One USB cable

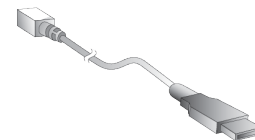

One XBee Smart Modem

---

**Note** The XBee Smart Modem comes attached to the board in ESD wrap.

---

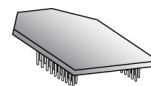

One SIM card

---

**Note** NB-IoT kits (Digi product number XK3-C-N1-UT-E) do not include a SIM card. Contact your NB-IoT mobile carrier provider to obtain a SIM card and service. See [Acquire a SIM card](#).

---



## Acquire a SIM card

NB-IoT kits (Digi product number XK3-C-N1-UT-E) do not include a SIM card. The sections below explain how to purchase an NB-IoT SIM card in the US and Europe.

### US customers

In the US, Digi XBee3® Cellular LTE-M/NB-IoT works with AT&T, Verizon, and T-Mobile. You must purchase a SIM card before you can connect the hardware. Contact Digi Sales at [www.digi.com/contactus](http://www.digi.com/contactus) for information about obtaining a SIM card and activating cellular service.

After you have purchased your SIM card, you must get the APN from the carrier. You will need this information when you get service. See [Configure module for NB-IoT](#).

The APN for NB-IoT on T-Mobile may be "iot.nb". You should confirm the APN when you set up service. You can contact Digi Sales at [www.digi.com/contactus](http://www.digi.com/contactus) for information about obtaining NB-IoT service.

### European customers

If you are using the NB-IoT European kit, you must purchase a SIM card before you can connect the hardware. Contact your NB-IoT mobile carrier provider to obtain a SIM card and service.

- Vodafone: [www.vodafone.com](http://www.vodafone.com)
- Deutsche Telekom: [www.telekom.com/en](http://www.telekom.com/en)

After you have purchased your SIM card, you can get the APN (if needed by your carrier), network bands, and supported channels from the carrier. You will need this information when configuring the device from the SIM card and service you have selected. See [Configure module for NB-IoT](#).

---

**Note** Some carriers in Europe do not use the APN with NB-IoT.

---

## Connect the hardware

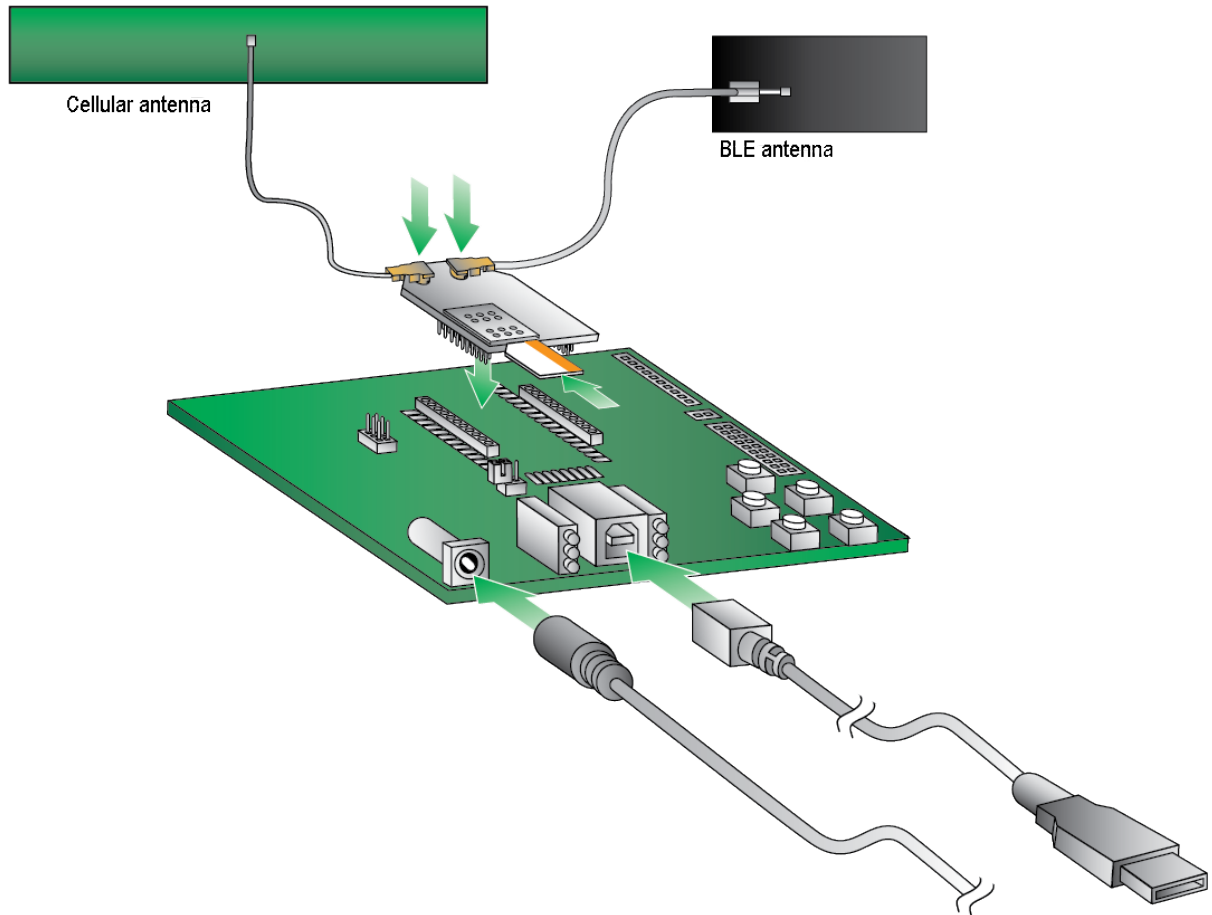

1. The XBee Smart Modem should already be plugged into the XBIB-U-DEV board.
2. If a SIM card is included with the kit, the card is inserted into the XBee Smart Modem. If a SIM card is not included, install the SIM card into the XBee Smart Modem before attaching the XBee device to the board.

**Note** NB-IoT kits (Digi product number XK3-C-N1-UT-E) do not include a SIM card. Contact your NB-IoT mobile carrier provider to obtain a SIM card and service. See [Acquire a SIM card](#).



**WARNING!** Never insert or remove the SIM card while the device is powered!

3. Attach the XBee device to the board.
4. Connect the antennas.
  - a. Connect the cellular antenna.
  - b. Connect the BLE antenna if you are using BLE functionality. If you are not, you do not have to connect the BLE antenna.

---

**Note** Align the U.FL connectors carefully, then firmly press straight down to seat the connector. You should hear a snap when the antenna attaches correctly. U.FL is fragile and is not designed for multiple insertions, so exercise caution when connecting or removing the antennas. We recommend using a U.FL removal tool.

---

5. Plug the 12 V power supply to the power jack on the development board. The LED indicator blinks when the board is powered.
6. Connect the USB cable from a PC to the USB port on the development board. The computer searches for a driver, which can take a few minutes to install. If you have trouble downloading the USB driver, see [Other possible issues](#).

## XBIB-U-DEV reference

This picture shows the XBee USB development board and the table that follows explains the callouts in the picture.

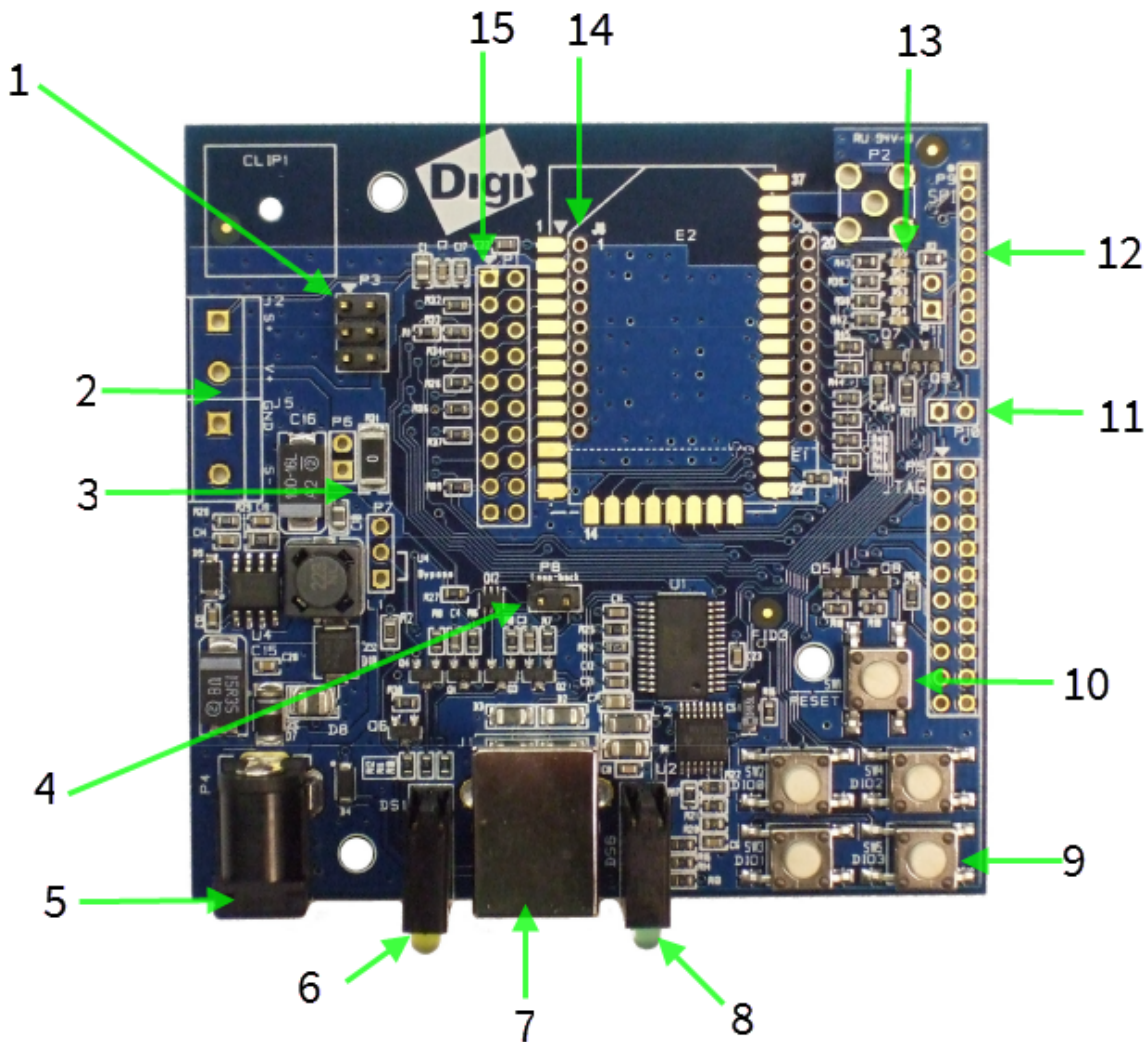

Number	Item	Description
1	Programming header	Header used to program XBee programmable devices.
2	Self power module	Advanced users only—voids the warranty. Depopulate R31 to power the device using V+ and GND from J2 and J5. You can connect sense lines to S+ and S- for sensing power supplies.   CAUTION: Voltage is not regulated. Applying the incorrect voltage can cause fire and serious injury. <sup>1</sup>
3	Current testing	Depopulating R31 allows a current probe to be inserted across P6 terminals. The current through P6/R31 powers the device only. Other supporting circuitry is powered by a different trace.
4	Loopback jumper	Populating P8 with a loopback jumper causes serial transmissions both from the device and from the USB to loopback.
5	DC barrel plug: 6-20 V	Greater than 500 mA loads require a DC supply for correct operation. Plug in the external power supply prior to the USB connector to ensure that proper USB communications are not interrupted.
6	LED indicator	Yellow: Modem sending serial/UART data to host. Green: Modem receiving serial/UART data from host. Red: Associate.
7	USB	Connects to your computer.
8	RSSI indicator	See <a href="#">RSSI PWM</a> . On the XBIB-U, more lights are better.
9	User buttons	Connected to DIO lines for user implementation.
10	Reset button	Press the reset button to reset the device to the default configuration.
11	SPI power	Connect to the power board from 3.3 V.
12	SPI	Only used for surface-mount devices.
13	Indicator LEDs	DS5: ON/SLEEP DS2: DIO12, the LED illuminates when driven low. DS3: DIO11, the LED illuminates when driven low. DS4: DIO4, the LED illuminates when driven low.
14	Through-hole XBee sockets	Connects the Digi XBee3 <sup>®</sup> Cellular LTE-M/NB-IoT modem to the XBee USB development board.
15	20-pin header	Maps to standard through-hole XBee pins. Male, Samtec header, part number: TSW-110-26-L-D. 2.54 mm / .100" pitch and row spacing.

<sup>1</sup>Powering the board with J2 and J5 without R31 removed can cause shorts if the USB or barrel plug power are connected. Applying too high a voltage destroys electronic circuitry in the device and other board components and/or can cause injury.

## XBIB-CU-TH reference

This picture shows the XBee-CU-TH development board and the table that follows explains the callouts in the picture.

**Note** This module is sold separately.

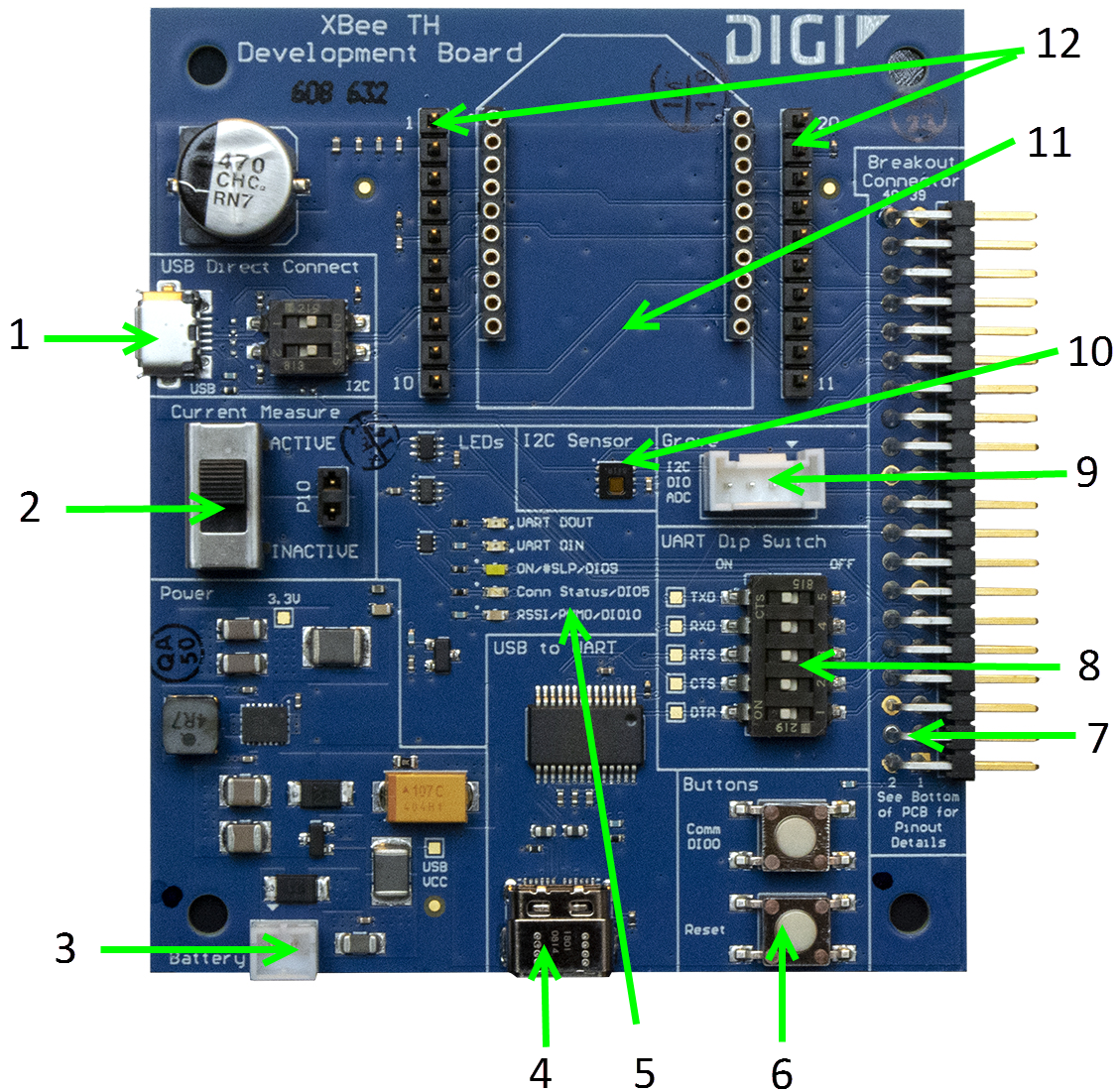

Number	Item	Description
1	Secondary USB (USB MICRO B) and DIP Switch	<p>Secondary USB Connector for direct programming of modules on some XBee units. Flip the Dip switches to the right for I2C access to the board; flip Dip switches to the left to disable I2C access to the board. The USB_P and USB_N lines are always connected to the XBee, regardless of Dip switch setting. This USB port is not designed to power the module or the board. Do not plug in a USB cable here unless the board is already being powered through the main USB-C connector. Do not attach a USB cable here if the Dip switches are pushed to the right.</p> <hr/> <div style="display: flex; align-items: center;">  <p><b>WARNING!</b> Direct input of USB lines into XBee units or I2C lines not designed to handle 5V can result in the destruction of the XBee or I2C components. Could cause fire or serious injury. Do not plug in a USB cable here if the XBee device is not designed for it and do not plug in a USB cable here if the Dip switches are pushed to the right.</p> </div> <hr/>
2	Current Measure	Large switch controls whether current measure mode is active or inactive. When inactive, current can freely flow to the VCC pin of the XBee. When active, the VCC pin of the XBee is disconnected from the 3.3 V line on the development board. This allows current measurement to be conducted by attaching a current meter across the jumper P10.
3	Battery Connector	If desired, a battery can be attached to provide power to the development board. The voltage can range from 2 V to 5 V. The positive terminal is on the left. If the USB-C connector is connected to a computer, the power will be provided through the USB-C connector and not the battery connector.
4	USB-C Connector	Connects to your computer and provides the power for the development board. This is connected to a USB to UART conversion chip that has the five UART lines passed to the XBee. The UART Dip Switch can be used to disconnect these UART lines from the XBee.
5	LED indicator	<p>Red: UART DOUT (modem sending serial/UART data to host)                      Green: UART DIN (modem receiving serial/UART data from host)                      White: ON/SLP/DIO9                      Blue: Connection Status/DIO5                      Yellow: RSSI/PWM0/DIO10</p>
6	User Buttons	<p>Comm DIO0 Button connects the Commissioning/DIO0 pin on the XBee Connector through to a 10 Ω resistor to GND when pressed.</p> <p>RESET Button Connects to the RESET pin on the XBee Connector to GND when pressed.</p>
7	Breakout Connector	This 40 pin connector can be used to connect to various XBee pins as shown on the silkscreen on the bottom of the board.



Number	Item	Description
8	UART Dip Switch	This dip switch allows the user to disconnect any of the primary UART lines on the XBee from the USB to UART conversion chip. This allows for testing on the primary UART lines without the USB to UART conversion chip interfering. Push Dip switches to the right to disconnect the USB to UART conversion chip from the XBee.
9	Grove Connector	This connector can be used to attach I2C enabled devices to the development board. Note that I2C needs to be available on the XBee in the board for this functionality to be used. Pin 1: I2C_CLK/XBee DIO1 Pin2: I2C_SDA/XBee DIO11 Pin3: VCC Pin4: GND
10	Temp/Humidity Sensor	This as a Texas Instruments HDC1080 temperature and humidity sensor. This part is accessible through I2C. Be sure that the XBee that is inserted into the development board has I2C if access to this sensor is desired.
11	XBee Socket	This is the socket for the XBee (TH form factor).
12	XBee Test Point Pins	Allows easy access for probes for all 20 XBee TH pins. Pin 1 is shorted to Pin 1 on the XBee and so on.

## XBIB-C-GPS reference

This picture shows the XBIB-C-GPS module and the table that follows explains the callouts in the picture.

---

**Note** This module is sold separately. You must also have purchased an [XBIB-CU-TH development board](#).

---

**Note** For a demo of how to use MicroPython to parse some of the GPS NMEA sentences from the UART, print them and report them to Digi Remote Manager, see [Run the MicroPython GPS demo](#).

---

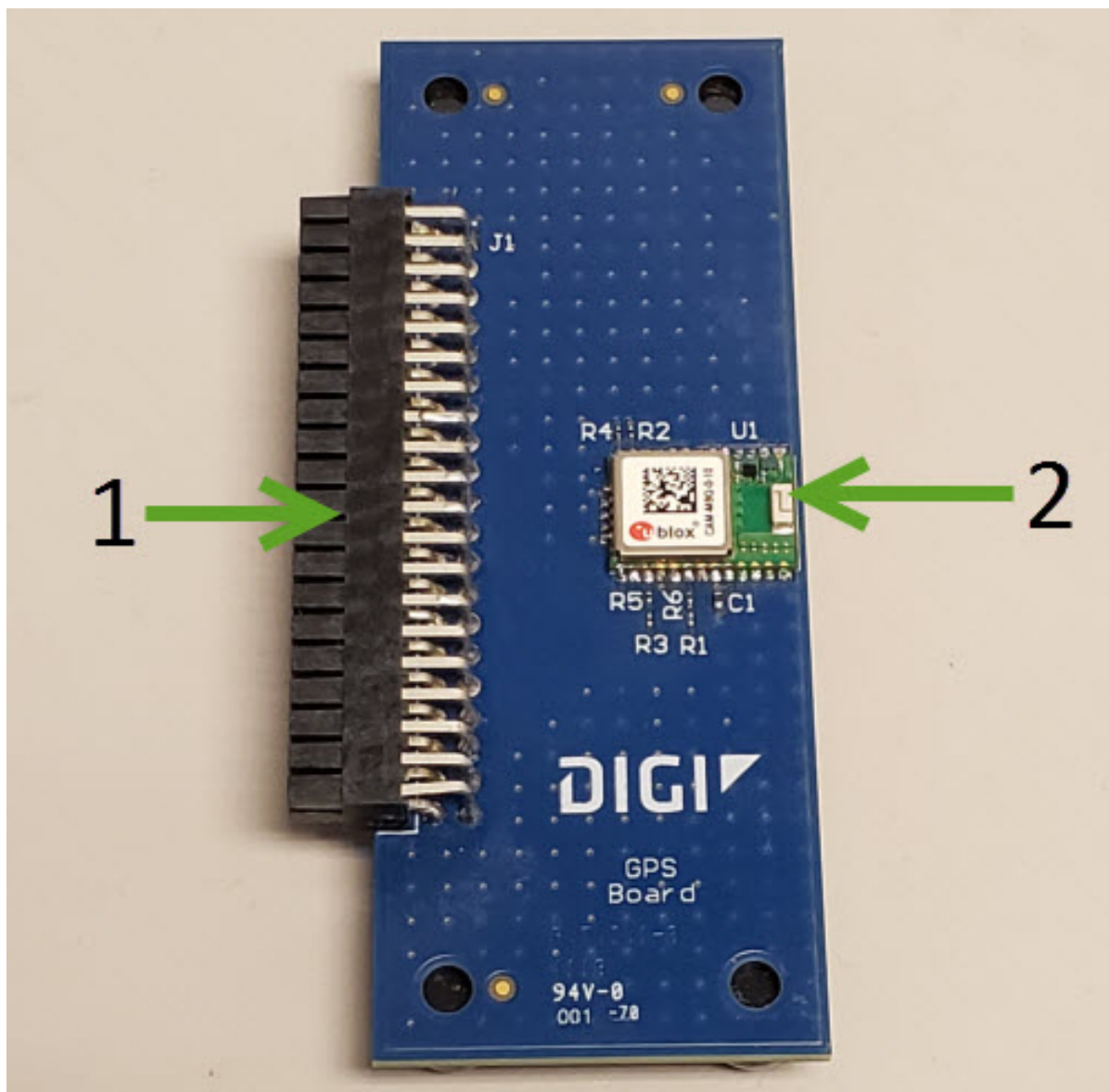

Number	Item	Description
1	40-pin header	This header is used to connect the XBIB-C-GPS board to a compatible XBIB development board. Insert the XBIB-C-GPS module slowly with alternating pressure on the upper and lower parts of the connector. If added or removed improperly, the pins on the attached board could bend out of shape.
2	GPS unit	This is the CAM-M8Q-0-10 module made by u-blox. This is what makes the GPS measurements. Proper orientation is with the board laying completely flat, with the module facing towards the sky.

## Interface with the XBIB-C-GPS module

The XBee Smart Modem can interface with the XBIB-C-GPS board through the large 40-pin header. This header is designed to fit into XBIB-C development board. This allows the XBee Smart Modem in the XBIB-C board to communicate with the XBIB-C-GPS board—provided the XBee device used has MicroPython capabilities (see [this link](#) to determine which devices have MicroPython capabilities). There are two ways to interface with the XBIB-C-GPS board: through the host board’s Secondary UART or through the I2C compliant lines.

The following picture shows a typical setup:



## I<sup>2</sup>C communication

There are two I<sup>2</sup>C lines connected to the host board through the 40-pin header, SCL and SDA. I<sup>2</sup>C communication is performed over an I<sup>2</sup>C-compliant Display Data Channel. The XBIB-C-GPS module operates in slave mode. The maximum frequency of the SCL line is 400 kHz. To access data through the I<sup>2</sup>C lines, the data must be queried by the connected XBee Smart Modem.

For more information about I<sup>2</sup>C Operation see the **I<sup>2</sup>C** section of the [Digi Micro Python Programming Guide](#).

For more information on the operation of the XBIB-C-GPS board see the [CAM-M8 datasheet](#). Other CAM-M8 documentation is located [here](#).

## UART communication

There are two UART pins connected from the XBIB-C-GPS to the host board by the 40-pin header: RX and TX. By default, the UART on the XBIB-C-GPS board is active and sends GPS readings to the connected device's secondary UART pins. Readings are transmitted once every second. The baud rate of the UART is 9600 baud.

For more information about using Micro Python to communicate to the XBIB-C-GPS module, see [Class UART](#).

## Run the MicroPython GPS demo

The Digi MicroPython github repository contains a GPS demo program that parses some of the GPS NMEA sentences from the UART, prints them and also reports them to Digi Remote Manager.

---

**Note** If you are unfamiliar with MicroPython on XBee you should first run some of the tutorials earlier in this manual to familiarize yourself with the environment. See [Get started with MicroPython](#). For more detailed information, refer to the [Digi MicroPython Programming Guide](#).

---

### **Step 1: Create a Remote Manager developer account**

You must have a Remote Manager developer account to be able to use this program. Make sure you know the user name and password for this account.

If you don't currently have a Remote Manager developer account, you can [create a free developer account](#).

### **Step 2: Download or clone the XBee MicroPython repository**

1. Navigate to: <https://github.com/digidotcom/xbee-micropython/>
2. Click **Clone or download**.
3. You must either clone or download a zip file of the repository. You can use either method.
  - **Clone:** If you are familiar with GIT, follow the standard GIT process to clone the repository.
  - **Download**
    - a. Click **Download zip** to download a zip file of the repository to the download folder of your choosing.
    - b. Extract the repository to a location of your choosing on your hard drive.

### Step 3: Edit the MicroPython file

1. Navigate to the location of the repository zip file that you created in Step 2.
2. Navigate to: **samples/gps**
3. Open the MicroPython file: *gpsdemo1.py*
4. Using the editor of your choice, edit the MicroPython file. At the top of the file, enter the user name and password for your Remote Manager developer account. The correct location is indicated in the comments in the file.

### Step 4: Run the program

1. Rename the file you edited in Step 3 from *gpsdemo1.py* to *main.py*.
2. Copy the renamed file onto your device's root filesystem directory.
3. Copy the following three modules from the locations specified below into your device's **/lib** directory:
  - From the **/lib** directory of the Digi xbee-micropython repository: *urequest.py* and *remotemanager.py*
  - From the **/lib/sensor** directory of the Digi xbee-micropython repository: *hdc1080.py*

---

**Note** These modules are required to be able to run the *gpsdemo1.py*.

---

4. Open **XCTU** and use the MicroPython Terminal to run the demo.
5. Type <CTRL>-R from the MicroPython prompt to run the code.

## Cellular service

Digi now offers Cellular Bundled Service plans. This service includes pre-configured cellular data options that are ideal for IoT applications, bundled together with Digi Remote Manager for customers who want to remotely monitor and manage their devices.

---

**Note** The Digi Cellular Bundled Service plan is not offered for NB-IoT. Contact Digi for more information about Digi Cellular Bundled Service.

---

To learn more, or obtain the plan that is right for your needs, contact us:

- By phone: 1-877-890-4014 (USA/toll free) or +1-952-912-3456 (International). Select the **Wireless Plan Support** or **Activation** option in the menu.
- By email: [Data.Plan.QuoteDesk@digi.com](mailto:Data.Plan.QuoteDesk@digi.com).



**WARNING!** Digi Remote Manager is enabled by default on the XBee device. You should configure the device to avoid excess cellular data usage. For more information, see [Configure Remote Manager keepalive interval](#).

---

The XBee Cellular kit includes six months of free cellular service. Six months of free cellular service assumes a rate of 5 MB/month. If you exceed a limit of 30 MB during the six month period your SIM will be deactivated.

---

**Note** The NB-IoT kit does not include free cellular service. Note that carriers put limits on your data service. Exceeding the allotted usage may result in automatic suspension or termination of service.

---

## Configure the device using XCTU

XBee Configuration and Test Utility (XCTU) is a multi-platform program developed by Digi that enables users to interact with Digi radio frequency (RF) devices through a graphical interface. The application includes built-in tools that make it easy to set up, configure, and test Digi RF devices.

XCTU does not work directly over an SPI interface.

For instructions on downloading and using XCTU, see the [XCTU User Guide](#).

---

**Note** If you are on a macOS computer and encounter problems installing XCTU, see [Correct a macOS Java error](#).

---

### Before you begin

1. To use XCTU, you may need to install FTDI Virtual COM port (VCP) drivers onto your computer. Click [here](#) to download the drivers for your operating system.
2. [Upgrade XCTU](#) to version 6.4.2 or later. This step is required.

### Add a device

These instructions show you how to add the XBee Smart Modem to XCTU.

If XCTU does not find your serial port, see [Cannot find the serial port for the device](#) and [Enable Virtual COM port \(VCP\) on the driver](#).

1. Launch XCTU .

---

**Note** XCTU's **Update the radio module firmware** dialog box may open and will not allow you to continue until you click **Update** or **Cancel** on the dialog.

---

2. Click **Help > Check for XCTU Updates** to ensure you are using the latest version of XCTU.
3. Click the **Discover radio modules** button  in the upper left side of the XCTU screen.
4. In the **Discover radio devices** dialog, select the serial ports where you want to look for XBee modules, and click **Next**.
5. In the **Set port parameters** window, maintain the default values and click **Finish**.
6. As XCTU locates radio modules, they appear in the **Discovering radio modules** dialog box.
7. Select the device(s) you want to add and click **Add selected devices**.

If your module could not be found, XCTU displays the **Could not find any radio module** dialog providing possible reasons why the module could not be added.



### Update to the latest firmware from XCTU

Firmware is the program code stored in the device's persistent memory that provides the control program for the device. Use XCTU to update the firmware.



**WARNING!** Version 1140F reorganizes the product's flash memory and upgrades the product to version 11410. You cannot downgrade to a version earlier than 11410 after installing 1140F/11410. You also need to use XCTU version 6.4.2 or later.

**Note** If you have already updated the firmware in a previous step, this process is not necessary.

1. Launch XCTU .
2. Click the **Configuration working modes** button .
3. Select a local XBee module from the **Radio Modules** list.
4. Click the **Update firmware** button  to ensure you have the most current firmware.  
The **Update firmware** dialog displays the available and compatible firmware for the selected XBee module.
5. Make sure you check the **Force the module to maintain its current configuration** box and then click **Update**.
6. Select the product family of the XBee module, the function set, and the latest firmware version.
7. Click **Update**. A dialog displays update progress. Click **Show details** for details of the firmware update process.

See [How to update the firmware of your modules](#) in the *XCTU User Guide* for more information.



## Configure module for NB-IoT

**Note** LTE-M is configured by default. You can skip this section if you are using LTE-M.

If you are using an NB-IoT kit, you must configure the device to use NB-IoT.

### US customers

**Note** Some carriers require an APN. If the carrier does not require an APN, you should not change the APN from the default

1. Click the **Configuration working modes** button .
2. Select an XBee module from the **Radio Modules** list.
3. Set the APN using the [AN command](#). You should get the APN from your carrier when you purchased your SIM card. See [Acquire a SIM card](#).
4. To set the APN, in the **AN** field, type the APN value from your carrier and click the **Write** button .

### European customers

**Note** Some carriers require an APN. If the carrier does not require an APN, you should not change the APN from the default

1. Click the **Configuration working modes** button .
2. Select an XBee module from the **Radio Modules** list.
3. Set the APN using the AN command. You should get the APN from your carrier when you purchased your SIM card. See [Acquire a SIM card](#).

To set the APN, in the **AN** field, type the APN value from your carrier and click the **Write** button .

4. Set the N# parameter to 3. In the **N#** field, select **NB-IoT Only [3]** and click the **Write** button .
5. Enable the bands. The bands are specified as a bit mask given as a hexadecimal value.

To enable bands 8 and 20, in the **BN** field, enter **80080** and click the **Write** button .

6. To set the **CP**, in the **CP** field, select **No Profile (1)** and click the **Write** button .
7. Reset the module with either the [reset button](#) or issue the [FR command](#).
8. Wait for a connection. You may wait for up to 5-6 minutes.
  - **If you have a connection:** This process is complete. The LED on the development board blinks when the XBee Smart Modem is registered to the cellular network. See [Check for cellular registration and connection](#).
  - **If you do not have a connection:** If the LED remains solid, registration has not occurred properly.
    - a. Repeat steps 1-5 to make sure you have correctly configured NB-IoT.
    - b. If you still do not have a connection, contact your carrier to confirm that the carrier has correctly configured the service.
      - If the carrier makes a change to the service, reset the module and wait 5-6 minutes.
      - If the carrier does not make a change to the service, then contact Digi support.

## Check for cellular registration and connection

In the following examples, proper cellular network registration and address assignment must occur successfully. The LED on the development board blinks when the XBee Smart Modem is registered to the cellular network; see [Associate LED functionality](#). If the LED remains solid, registration has not occurred properly.

Registration typically takes 5 - 6 minutes the first time a device is connected to the network.

---

**Note** Make sure you are in an area with adequate cellular network reception or the XBee Smart Modem will not make the connection.

---

**Note** Check the antenna connections if the device has trouble connecting to the network.

---

In addition to the LED confirmation, you can check the AT commands below in XCTU to check the registration and connection.

To view these commands:



1. You must have previously added at least one device. See [Add a device](#).
2. Open XCTU.
3. Click the **Configuration working mode**  button.
4. Select a device from the **Radio Modules** list. XCTU displays the current firmware settings for that device.

---

**Note** To search for an AT command in XCTU, use [the search box](#) .

---

The relevant commands are:

- **AI (Association Indication)** reads **0** when the device successfully registers to the cellular network. If it reads **23** it is connecting to the Internet; **22** means it is registering to the cellular network.
- **MY (Module IP Address)** should display a valid IP address. If it reads **0.0.0.0**, it has not registered yet.

---

**Note** To read a command's value, click the **Read** button  next to the command.

---

## XBee bootloader

XBee devices use a modified version of Ember's bootloader. This bootloader version supports a custom entry mechanism that uses module pins DIN (pin 3), DTR / SLEEP\_RQ (SLEEP\_RQ), and RTS (pin 16).

To invoke the bootloader, do the following:

1. Set DTR/SLEEP\_RQ low (TTL 0V) and RTS high.
2. Send a serial break to the DIN pin and power cycle or reset the module.
3. When the device powers up, set DTR/SLEEP\_RQ and DIN to low (TTL 0V) and RTS should be high.
4. Terminate the serial break and send a carriage return at 115200 baud to the device.
5. If successful, the device sends the Ember bootloader menu out the DOUT pin at 115200 baud.
6. Commands can be sent to the bootloader at 115200 b/s.

---

**Note** Disable hardware flow control when entering and communicating with the XBee3 cellular bootloader.

---

All serial communications with the module use 8 data bits, no parity bit, and 1 stop bit.

You can update firmware on the XBee Smart Modem serially. This is done by invoking the bootloader and transferring the firmware image using XMODEM.

## XBee connection examples

---

The following examples provide some additional scenarios you can try to get familiar with the XBee Smart Modem. These examples are focused on inter-operating with a host processor to drive the XBee.

If you are interested in using the intelligence built into the XBee, see [Get started with MicroPython](#).

---

**Note** Some carriers restrict your internet access. If access is restricted, running some of these examples may not be possible. Check with your carrier provider to determine whether internet access is restricted.

---

Connect to the Echo server .....	35
Connect to the ELIZA server .....	37
Connect to the Daytime server .....	39
Perform a (GET) HTTP request .....	41
Get started with CoAP .....	43
Connect to a TCP/IP address .....	47
Get started with MQTT .....	48
Debugging .....	56
Software libraries .....	56

## Connect to the Echo server

This server echoes back the messages you type.

You may use TCP or UDP, depending on the protocols supported by your network carrier.

---



**Note** For help with debugging, see [Debugging](#).

---

The following table explains the AT commands that you use in this example.

At command	Value	Description
<b>IP</b> (IP Protocol)	1	TCP: Set the expected transmission mode to TCP communications.
	0	UDP: Set the expected transmission mode to UDP communications.
<b>TD</b> (Text Delimiter)	D (0x0D)	The text delimiter to be used for Transparent mode, as an ASCII hex code. No information is sent until this character is entered, unless the maximum number of characters has been reached. Set to <b>0</b> to disable text delimiter checking. Set to <b>D</b> for a carriage return.
<b>DL</b> (Destination Address)	52.43.121.77	The target IP address of the echo server.  <b>Note</b> Some carriers may require whitelisted IP addresses. If this IP is not whitelisted by your carrier you will not be able to run this example.
<b>DE</b> (Destination Port)	0x2329	TCP: The target port number of the TCP echo server. This port in decimal is 9001.
	0x2711	UDP: The target port number of the UDP echo server. This port in decimal is 10001.



To communicate with the Echo server:

1. Ensure that the device is set up correctly with the SIM card installed and the antennas connected as described in [Connect the hardware](#).
2. Open XCTU and [Add a device](#).
3. Click the **Configuration working mode**  button.
4. Select a device from the **Radio Modules** list. XCTU displays the current firmware settings for that device.
5. To switch to TCP communication, in the **IP** field, select 1 and click the **Write** button .
6. To enable the XBee Smart Modem to recognize carriage return as a message delimiter, in the **TD** field, type **D** and click the **Write** button.
7. To enter the destination address of the echo server, in the **DL** field, type **52.43.121.77** and click the **Write** button.
8. To enter the destination IP port number, in the **DE** field, type **2329** and click the **Write** button.

---

**Note** XCTU does not follow the standard hexadecimal numbering convention. The leading 0x is not needed in XCTU.

---

9. Click the **Consoles working mode** button  on the toolbar to open a serial console to the device. For instructions on using the Console, see the [AT console](#) topic in the *XCTU User Guide*.
10. Click the **Open** button  to open a serial connection to the device.
11. Click in the left pane of the **Console log**, then type in the Console to talk to the echo server. The following screenshot provides an example of this chat.

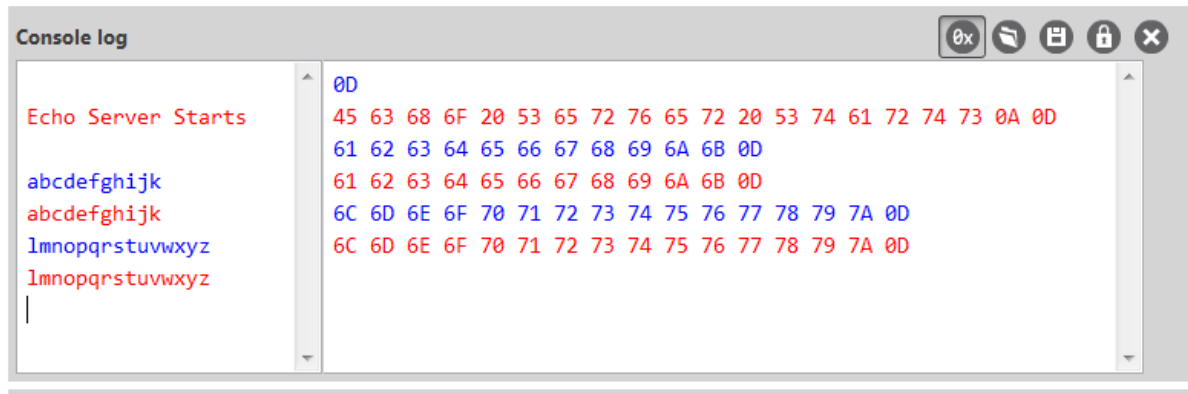

## Connect to the ELIZA server





You can use the XBee Smart Modem to chat with the ELIZA Therapist Bot. ELIZA is an artificial intelligence (AI) bot that emulates a therapist and can perform simple conversations.

**Note** For help with debugging, see [Debugging](#).

The following table explains the AT commands that you use in this example.

At command	Value	Description
<b>IP</b> (IP Protocol)	1	Set the expected transmission mode to TCP communications.
<b>DL</b> (Destination Address)	52.43.121.77	The target IP address of the ELIZA server.  <b>Note</b> Some carriers may require whitelisted IP addresses. If this IP is not whitelisted by your carrier you will not be able to run this example.
<b>DE</b> (Destination Port)	0x2328	The target port number of the ELIZA server.

To communicate with the ELIZA Therapist Bot:

1. Ensure that the device is set up correctly with the SIM card installed and the antennas connected as described in [Connect the hardware](#).
2. Open XCTU and [Add a device](#).
3. Click the **Configuration working mode**  button.
4. Select a device from the **Radio Modules** list. XCTU displays the current firmware settings for that device.
5. To switch to TCP communication, in the **IP** field, select 1 and click the **Write** button .
6. To enter the destination address of the ELIZA Therapist Bot, in the **DL** field, type **52.43.121.77** and click the **Write** button.
7. To enter the destination IP port number, in the **DE** field, type **2328** and click the **Write** button.
8. Click the **Consoles working mode** button  on the toolbar to open a serial console to the device. For instructions on using the Console, see the [AT console](#) topic in the [XCTU User Guide](#).
9. Click the **Open** button  to open a serial connection to the device.
10. Click in the left pane of the **Console log**, then type in the Console to talk to the ELIZA Therapist Bot. The following screenshot provides an example of this chat with the user's text in blue.

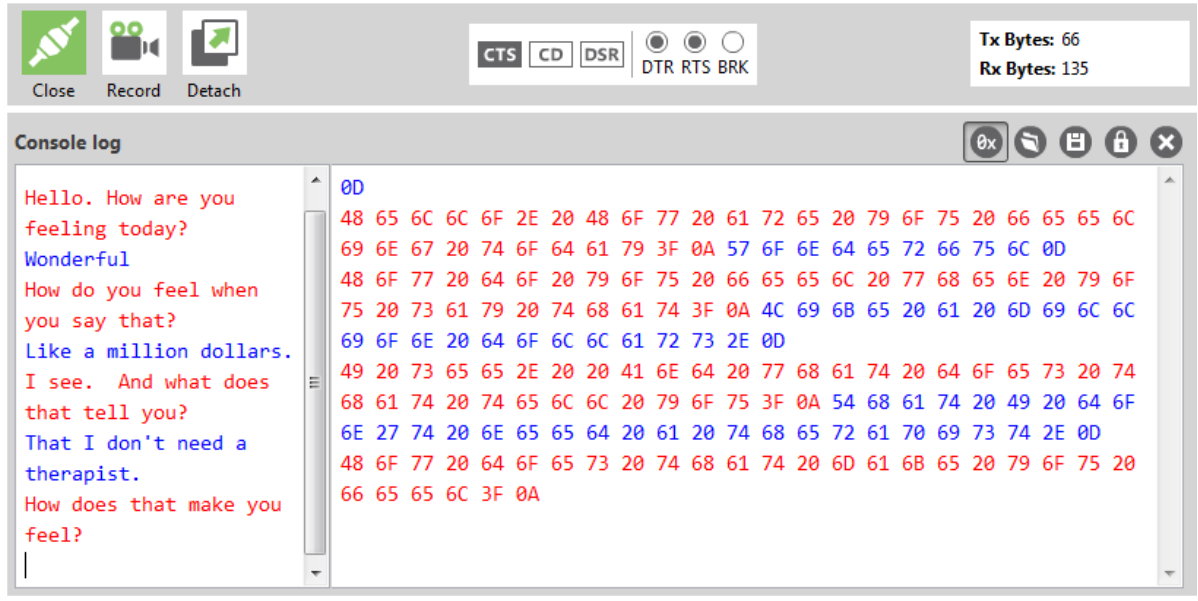

## Connect to the Daytime server





The Daytime server reports the current Coordinated Universal Time (UTC) value responding to any user input.

**Note** For help with debugging, see [Debugging](#).

The following table explains the AT commands that you use in this example.

At command	Value	Description
<b>IP</b> (IP Protocol)	1	Set the expected transmission mode to TCP communications.
<b>DL</b> (Destination Address)	52.43.121.77	The target IP of the Daytime server.  <b>Note</b> Some carriers may require whitelisted IP addresses. If this IP is not whitelisted by your carrier you will not be able to run this example.
<b>DE</b> (Destination Port)	0x232A	The target port number of the Daytime server.
<b>TD</b> (Text Delimiter)	0	The text delimiter to be used for Transparent mode, as an ASCII hex code. No information is sent until this character is entered, unless the maximum number of characters has been reached. Set to zero to disable text delimiter checking.

To communicate with the Daytime server:

1. Ensure that the device is set up correctly with the SIM card installed and the antennas connected as described in [Connect the hardware](#).
2. Open XCTU and [Add a device](#).
3. Click the **Configuration working mode**  button.
4. Select a device from the **Radio Modules** list. XCTU displays the current firmware settings for that device.
5. To switch to TCP communication, in the **IP** field, select 1 and click the **Write** button .
6. To enter the destination address of the daytime server, in the **DL** field, type **52.43.121.77** and click the **Write** button.
7. To enter the destination IP port number, in the **DE** field, type **232A** and click the **Write** button.
8. To disable text delimiter checking, in the **TD** field, type **0** and click the **Write** button.
9. Click the **Consoles working mode**  button on the toolbar to open a serial console to the device. For instructions on using the Console, see the [AT console](#) topic in the *XCTU User Guide*.
10. Click the **Open** button  to open a serial connection to the device.

11. Click in the left pane of the **Console log**, then type in the Console to query the Daytime server. The following screenshot provides an example of this chat.

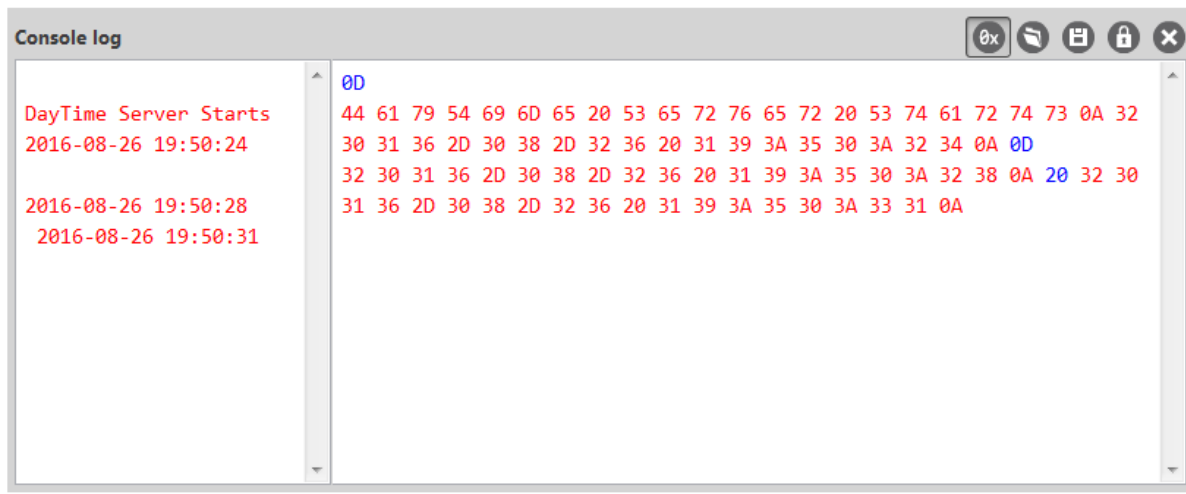



## Perform a (GET) HTTP request





You can use the XBee Smart Modem to perform a GET Hypertext Transfer Protocol (HTTP) request using XCTU. HTTP is an application-layer protocol that runs over TCP. This example uses [httpbin.org/](http://httpbin.org/) as the target website that responds to the HTTP request.

---

**Note** For help with debugging, see [Debugging](#).

---

To perform a GET request:

1. Ensure that the device is set up correctly with the SIM card installed and the antennas connected as described in [Connect the hardware](#).
2. Open XCTU and [Add a device](#).
3. Click the **Configuration working mode**  button.
4. Select a device from the **Radio Modules** list. XCTU displays the current firmware settings for that device.
5. To enter the destination address of the target website, in the **DL** field, type **httpbin.org** and click the **Write** button .
6. To enter the HTTP request port number, in the **DE** field, type **50** and click the **Write** button. Hexadecimal **50** is 80 in decimal.
7. To switch to TCP communication, in the **IP** field, select **1** and click the **Write** button.
8. To move into Transparent mode, in the **AP** field, select **0** and click the **Write** button.
9. Wait for the **AI** (Association Indication) value to change to **0** (Connected to the Internet).
10. Click the **Consoles working mode** button  on the toolbar.
11. From the AT console, click the **Add new packet button**  in the Send packets dialog. The **Add new packet** dialog appears.
12. Enter the name of the data packet.
13. Type the following data in the **ASCII** input tab:
 

```
GET /ip HTTP/1.1
Host: httpbin.org
```
14. Click the **HEX** input tab and add **0A** (zero A) after each **0D** (zero D), and add an additional **0D 0A** at the end of the message body. For example, copy and past the following text into the **HEX** input tab:
 

```
47 45 54 20 2F 69 70 20 48 54 54 50 2F 31 2E 31 0D 0A 48 6F 73 74 3A 20 68 74 74 70 62 69 6E
2E 6F 72 67 0D 0A 0D 0A
```

---

**Note** The HTTP protocol requires an empty line (a line with nothing preceding the CRLF) to terminate the request.

---

15. Click **Add packet**.
16. Click the **Open** button .

17. Click **Send selected packet**.
18. A GET HTTP response from [httpbin.org](http://httpbin.org) appears in the Console log.

## Get started with CoAP

Constrained Application Protocol (CoAP) is based on UDP connection and consumes low power to deliver similar functionality to HTTP. This guide contains information about sending GET, POST, PUT and DELETE operations by using the Coap Protocol with XCTU and Python code working with the XBee Smart Modem and Coapthon library (Python 2.7 only).

The Internet Engineering Task Force describes CoAP as:

The protocol is designed for machine-to-machine (M2M) applications such as smart energy and building automation. CoAP provides a request/response interaction model between application endpoints, supports built-in discovery of services and resources, and includes key concepts of the Web such as URIs and Internet media types. CoAP is designed to easily interface with HTTP for integration with the Web while meeting specialized requirements such as multicast support, very low overhead, and simplicity for constrained environments ([source](#)).

### CoAP terms

When describing CoAP, we use the following terms:

Term	Meaning
Method	COAP's method action is similar to the HTTP method. This guide discusses the GET, POST, PUT and DELETE methods. With these methods, the XBee Smart Modem can transport data and requests.
URI	URI is a string of characters that identifies a resource served at the server.
Token	A token is an identifier of a message. The client uses the token to verify if the received message is the correct response to its query.
Payload	The message payload is associated with the POST and PUT methods. It specifies the data to be posted or put to the URI resource.
Message ID	The message ID is also an identifier of a message. The client matches the message ID between the response and query.

### CoAP quick start example

The following diagram shows the message format for the CoAP protocol; see [ISSN: 2070-1721](#) for details:

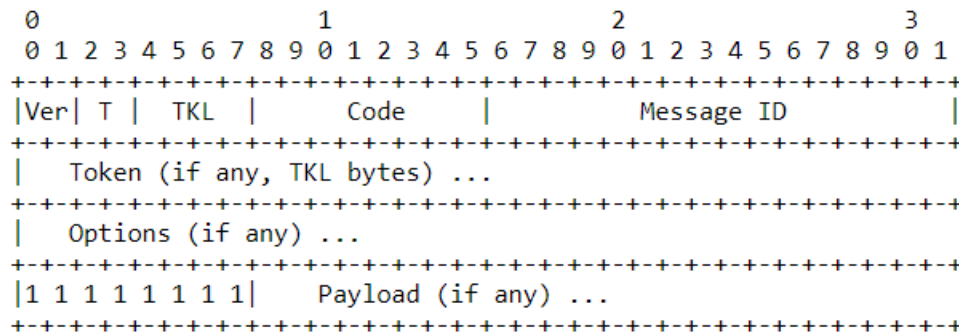





This is an example GET request:

```
44 01 C4 09 74 65 73 74 B7 65 78 61 6D 70 6C 65
```

The following table describes the fields in the GET request.



Field	HEX	Bits	Meaning
Ver	44	01	Version 01, which is mandatory here.
T		00	Type 0: confirmable.
TKL		0100	Token length: 4.
Code	01	000 00001	Code: 0.01, which indicates the GET method.
Message ID	C4 09	2 Bytes equal to hex at left	Message ID. The response message will have the same ID. This can help out identification.
Token	74 65 73 74	4 Bytes equal to hex at left	Token. The response message will have the same token. This can help out identification.
Option delta	B7	1011	Delta option: 11 indicates the option data is Uri-Path.
Option length		0111	Delta length: 7 indicates there are 7 bytes of data following as a part of this delta option.
Option value	65 78 61 6D 70 6C 65	7 Bytes equal to hex at left	Example.

## Configure the device

1. Ensure that the device is set up correctly with the SIM card installed and the antennas connected as described in [Connect the hardware](#).
2. Open XCTU and click the **Configuration working mode**  button.
3. Add the XBee Smart Modem to XCTU; see [Add a device](#).
4. Select a device from the **Radio Modules** list. XCTU displays the current firmware settings for that device.
5. To switch to UDP communication, in the **IP** field, select **0** and click the **Write** button .
6. To set the target IP address that the XBee Smart Modem will talk to, in the **DL** field type **52.43.121.77** and click the **Write** button . A CoAP server is publicly available at address 52.43.121.77.
7. To set the XBee Smart Modem to send data to port 5683 in decimal, in the **DE** field, type **1633** and click the **Write** button.
8. To move into Transparent mode, in the **AP** field, select **0** and click the **Write** button.
9. Wait for the **AI** (Association Indication) value to change to **0** (Connected to the Internet). You can click **Read**  to get an update on the **AI** value.

## Example: manually perform a CoAP request

Follow the steps in [Configure the device](#) prior to this example. This example performs the CoAP GET request:

- Method: GET
  - URI: example
  - Given message token: test
1. Click the **Consoles working mode** button  on the toolbar to add a customized packet.
  2. From the AT console, click the **Add new packet button**  in the Send packets dialog. The **Add new packet** dialog appears.
  3. Click the **HEX** tab and type the name of the data packet: **GET\_EXAMPLE**.
  4. Copy and past the following text into the **HEX** input tab:  
44 01 C4 09 74 65 73 74 B7 65 78 61 6D 70 6C 65  
This is the CoAP protocol message decomposed by bytes to perform a GET request on an example URI with a token test.
  5. Click **Add packet**.
  6. Click the **Open** button .
  7. Click **Send selected packet**. The message is sent to the public CoAP server configured in [Configure the device](#). A response appears in the Console log. Blue text is the query, red text is the response.

The payload is **Get to uri: example**, which specifies that this is a successful CoAP GET to URI end example, which was specified in the query.

Click the **Close** button to terminate the serial connection.

## Example: use Python to generate a CoAP message

This example illustrates how the CoAP protocol can perform GET/POST/PUT/DELETE requests similarly to the HTTP protocol and how to do this using the XBee Smart Modem. In this example, the XBee Smart Modem talks to a CoAP Digi Server. You can use this client code to provide an abstract wrapper to generate a CoAP message that commands the XBee Smart Modem to talk to the remote CoAP server.

---

**Note** It is crucial to configure the XBee Smart Modem settings. See [Configure the device](#) and follow the steps. You can target the IP address to a different CoAP public server.

---

1. Install Python 2.7. The Installation guide is located at: [python.org/downloads/](http://python.org/downloads/).
2. Download and install the CoAPthon library in the python environment from [pypi.python.org/pypi/CoAPthon](http://pypi.python.org/pypi/CoAPthon).
3. Download these two .txt files: [Coap.txt](#) and [CoapParser.txt](#). After you download them, open the files in a text editor and save them as .py files.
4. In the folder that you place the Coap.py and CoapParser.py files, press **Shift + right-click** and then click **Open command window**.
5. At the command prompt, type **python Coap.py** and press **Enter** to run the program.
6. Type the USB port number that the XBee Smart Modem is connected to and press **Enter**. Only the port number is required, so if the port is COM19, type 19.

**Note** If you do not know the port number, open XCTU and look at the XBee Smart Modem in the **Radio Modules** list. This view provides the port number and baud rate, as in the figure below where the baud rate is 9600 b/s.

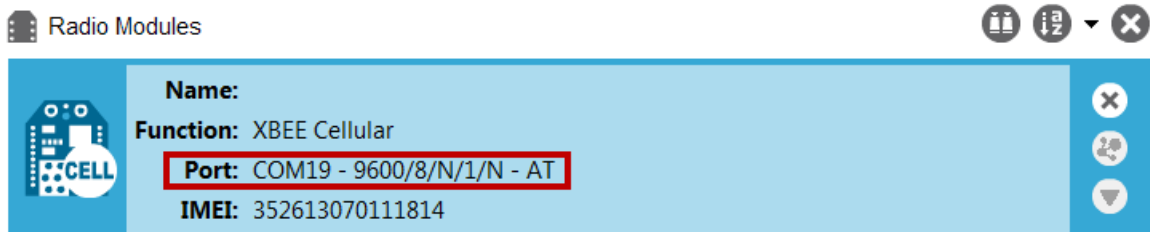

7. Type the baud rate and press **Enter**. You must match the device's current baud rate. XCTU provides the current baud rate in the **BD Baud Rate** field. In this example you would type **9600**.
8. Press **Y** if you want an auto-generated example. Press **Enter** to build your own CoAP request.
9. If you press **Y** it generates a message with:
  - Method: POST
  - URI: example
  - payload: hello world
  - token: test

The send and receive message must match the same token and message id. Otherwise, the client re-attempts the connection by sending out the request.

In the following figure, the payload contains the server response to the query. It shows the results for when you press **Enter** rather than **Y**.

```
C:\Users\jzhang\Desktop\example>python Coap.py
Please enter the serial port number for Xbee: 18
Please enter the baudrate number of Xbee: (9600 or 115200): 9600
Do you want an auto-generated example <Press Y> or build your own <Press ENTER>:

Please enter the HTTP method (GET, POST, PUT, DELETE): PUT
Please enter the uri end path: example
Please enter the payload content. And it cannot be empty: hello world
Please enter the token: digi

#####

This is the send out message:
Source: (None, None)
Destination: None
Type: CON
MID: 56045
Code: PUT
Token: digi
Uri-Path: example
Payload:
hello world

This is the received message
Source: (None, None)
Destination: None
Type: ACK
MID: 56045
Code: CHANGED
Token: digi
Payload:
Put hello world to uri: example
```

## Connect to a TCP/IP address

The XBee Smart Modem can send and receive TCP messages while in Transparent mode; see [Transparent operating mode](#).



**Note** You can use this example as a template for sending and receiving data to or from any TCP/IP server.

**Note** For help with debugging, see [Debugging](#).

The following table explains the AT commands that you use in this example.

Command	Value	Description
<b>IP</b> (IP Protocol)	1	Set the expected transmission mode to TCP communication.
<b>DL</b> (Destination IP Address)	<Target IP address>	The target IP address that you send and receive from. For example, a data logging server's IP address that you want to send measurements to.
<b>DE</b> (Destination Port)	<Target port number>	The target port number that the device sends the transmission to. This is represented as a hexadecimal value.

To connect to a TCP/IP address:

1. Ensure that the device is set up correctly with the SIM card installed and the antennas connected as described in [Connect the hardware](#).
2. Open XCTU and [Add a device](#).
3. Click the **Configuration working mode**  button.
4. Select a device from the **Radio Modules** list. XCTU displays the current firmware settings for that device.
5. In the **IP** field, select 1 and click the **Write** button .
6. In the **DL** field, type the <target IP address> and click the **Write** button. The target IP address is the IP address that you send and receive from.
7. In the **DE** field, type the <target port number>, converted to hexadecimal, and click the **Write** button.
8. [Exit Command mode](#).

After exiting Command mode, any UART data sent to the device is sent to the destination IP address and port number after the [RO \(Packetization Timeout\)](#) occurs.

## Get started with MQTT

MQ Telemetry Transport (MQTT) is a messaging protocol that is ideal for the Internet of Things (IoT) due to a light footprint and its use of the publish-subscribe model. In this model, a client connects to a broker, a server machine responsible for receiving all messages, filtering them, and then sending messages to the appropriate clients.

The first two MQTT examples do not involve the XBee Smart Modem. They demonstrate using the MQTT libraries because those libraries are required for [Use MQTT over the XBee Cellular Modem with a PC](#).

The examples in this guide assume:

- Some knowledge of Python.
- An integrated development environment (IDE) such as PyCharm, IDLE or something similar.

The examples require:

- An XBee Smart Modem.
- A compatible development board, such as the XBIB-U.
- XCTU. See [Configure the device using XCTU](#).
- That you install Python on your computer. You can download Python from: <https://www.python.org/downloads/>.
- That you install the **pyserial** and **paho-mqtt** libraries to the Python environment. If you use Python 2, install these libraries from the command line with **pip install pyserial** and **pip install paho-mqtt**. If you use Python 3, use **pip3 install pyserial** and **pip3 install paho-mqtt**.
- The full MQTT library source code, which includes examples and tests, which is available in the paho-mqtt github repository at <https://github.com/eclipse/paho.mqtt.python>. To download this repository you must have Git installed.

### Example: MQTT connect

This example provides insight into the structure of packets in MQTT as well as the interaction between the client and broker. MQTT uses different packets to accomplish tasks such as connecting, subscribing, and publishing. You can use XCTU to perform a basic example of sending a broker a connect packet and receiving the response from the server, without requiring any coding. This is a good way to see how the client interacts with the broker and what a packet looks like. The following table is an example connect packet:

	Description	Hex value
CONNECT packet fixed header		
byte 1	Control packet type	0x10
byte 2	Remaining length	0x10
CONNECT packet variable header		
Protocol name		



	Description	Hex value
byte 1	Length MSB (0)	0x00
byte 2	Length LSB (4)	0x04
byte 3	(M)	0x4D
byte 4	(Q)	0x51
byte 5	(T)	0x54
byte 6	(T)	0x54
Protocol level		
byte 7	Level (4)	0x04
Connect flags		
byte 8	CONNECT flags byte, see the table below for the bits.	0X02
Keep alive		
byte 9	Keep Alive MSB (0)	0X00
byte 10	Keep Alive LSB (60)	0X3C
Client ID		
byte 11	Length MSB (0)	0x00
byte 12	Length LSB (4)	0x04
byte 13	(D)	0x44
byte 14	(I)	0x49
byte 15	(G)	0x47
byte 16	(I)	0x49

The following table describes the fields in the packet:

Field name	Description
Protocol Name	The connect packet starts with the protocol name, which is MQTT. The length of the protocol name (in bytes) is immediately before the name itself.
Protocol Level	Refers to the version of MQTT in use, in this case a value of 4 indicates MQTT version 3.1.1.
Connect Flags	Indicate certain aspects of the packet. For simplicity, this example only sets the Clean Session flag, which indicates to the client and broker to discard any previous session and start a new one.
Keep Alive	How often the client pings the broker to keep the connection alive; in this example it is set to 60 seconds.





Field name	Description
Client ID	The length of the ID (in bytes) precedes the ID itself. Each client connecting to a broker must have a unique client ID. In the example, the ID is DIGI. When using the Paho MQTT Python libraries, a random alphanumeric ID is generated if you do not specify an ID.

The following table provides the CONNECT flag bits from byte 8, the CONNECT flags byte.

CONNECT Flag Bit(s)	Bit 7	Bit 6	Bit 5	Bit 4	Bit 3	Bit 2	Bit 1	Bit 0
User name flag	0							
Password flag		0						
Will retain			0					
Will QoS				0	0			
Will flag						0		
Clean session							1	
Reserved								0

## Send a connect packet

Now that you know what a connect packet looks like, you can send a connect packet to a broker and view the response. Open XCTU and click the Configuration working mode button.

1. Ensure that the device is set up correctly with the SIM card installed and the antennas connected as described in [Connect the hardware](#).
2. Open XCTU and click the **Configuration working mode**  button.
3. Add the XBee Smart Modem to XCTU. See [Add a device](#).
4. Select a device from the **Radio Modules** list. XCTU displays the current firmware settings for that device.
5. In the **AP** field, set **Transparent Mode** to **[0]** if it is not already and click the **Write** button.
6. In the **DL** field, type the IP address or the fully qualified domain name of the broker you wish to use. This example uses [test.mosquitto.org](http://test.mosquitto.org).
7. In the **DE** field, type **75B** and set the port that the broker uses. This example uses **75B**, because the default MQTT port is 1883 (0x75B).
8. Once you have entered the required values, click the **Write** button to write the changes to the XBee Smart Modem.
9. Click the **Consoles working mode** button  on the toolbar to open a serial console to the device. For instructions on using the Console, see the [AT console](#) topic in the [XCTU User Guide](#).
10. Click the **Open** button  to open a serial connection to the device.
11. From the AT console, click the **Add new packet button**  in the **Send packets** dialog. The **Add new packet** dialog appears.

12. Enter the name of the data packet. Name the packet **connect\_frame** or something similar.
13. Click the **HEX** input tab and type the following (these values are the same values from the table in [Example: MQTT connect](#)):

**10 10 00 04 4D 51 54 54 04 02 00 3C 00 04 44 49 47 49**

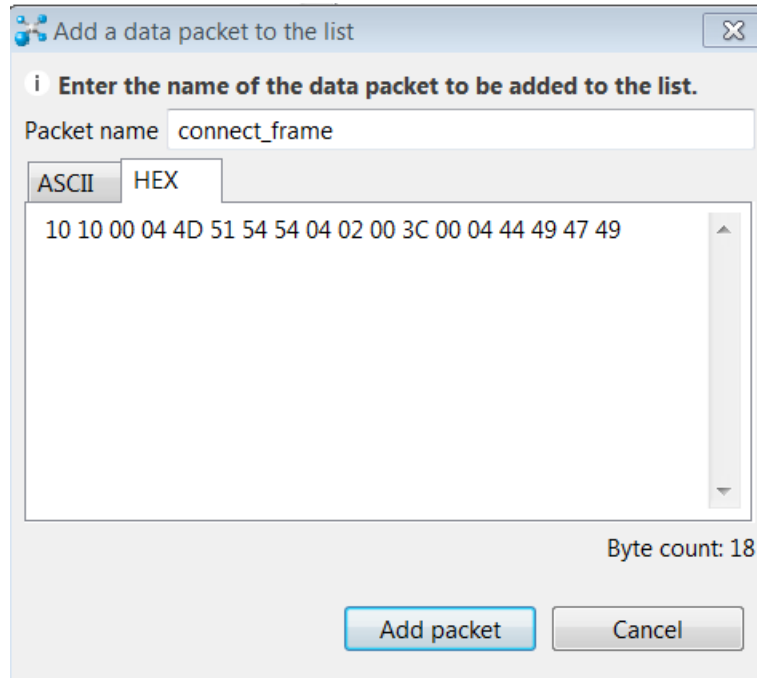

14. Click **Add packet**. The new packet appears in the **Send packets** list.
15. Click the packet in the **Send packets** list.
16. Click **Send selected packet**.
17. A CONNACK packet response from the broker appears in the **Console log**. This is a connection acknowledgment; a successful response should look like this:

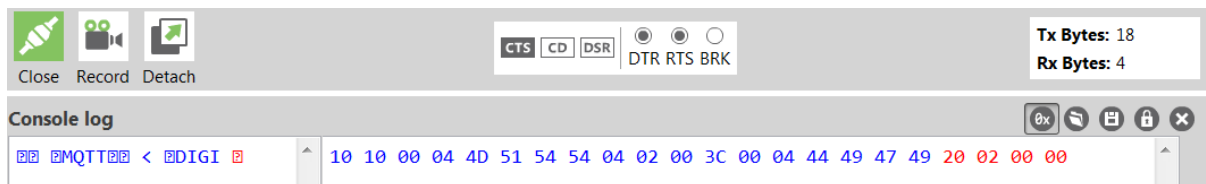

You can verify the response from the broker as a CONNACK by comparing it to the structure of a CONNACK packet in the MQTT documentation, which is available at [http://docs.oasis-open.org/mqtt/mqtt/v3.1.1/os/mqtt-v3.1.1-os.html#\\_Toc398718081](http://docs.oasis-open.org/mqtt/mqtt/v3.1.1/os/mqtt-v3.1.1-os.html#_Toc398718081).

### Example: send messages (publish) with MQTT

A basic Python example of a node publishing (sending) a message is:

```

mqttc = mqtt.Client("digitest") # Create instance of client with client ID
"digitest"
mqttc.connect("m2m.eclipse.org", 1883) # Connect to (broker, port,
keepalive-time)
    
```

---

```

mqttc.loop_start() # Start networking daemon
mqttc.publish("digitest/test1", "Hello, World!") # Publish message to
"digitest /test1" topic
mqttc.loop_stop() # Kill networking daemon

```

---

**Note** You can easily copy and paste code from the [online version of this guide](#). Use caution with the PDF version, as it may not maintain essential indentations.

---

This example imports the MQTT library, allowing you to use the MQTT protocol via APIs in the library, such as the **connect()**, **subscribe()**, and **publish()** methods.

The second line creates an instance of the client, named **mqttc**. The client ID is the argument you passed in: **digitest** (this is optional).

In line 3, the client connects to a public broker, in this case **m2m.eclipse.org**, on port **1883** (the default MQTT port, or 8883 for MQTT over SSL). There are many publicly available brokers available, you can find a list of them here: <https://github.com/mqtt/mqtt.github.io/wiki/brokers>.

Line 4 starts the networking daemon with **client.loop\_start()** to handle the background network/data tasks.

Finally, the client publishes its message **Hello, World!** to the broker under the topic **digitest/backlog/test1**. Any nodes (devices, phones, computers, even microcontrollers) subscribed to that same topic on the same broker receive the message.

Once no more messages need to be published, the last line stops the network daemon with **client.loop\_stop()**.

## Example: receive messages (subscribe) with MQTT

This example describes how a client would receive messages from within a specific topic on the broker:

---

```

import paho.mqtt.client as mqtt

def on_connect(client, userdata, flags, rc): # The callback for when the
client connects to the broker
    print("Connected with result code {}".format(str(rc))) # Print result
of connection attempt
    client.subscribe("digitest/test1") # Subscribe to the topic
"digitest/test1", receive any messages published on it

def on_message(client, userdata, msg): # The callback for when a PUBLISH
message is received from the server.
    print("Message received-> " + msg.topic + " " + str(msg.payload)) #
Print a received msg

client = mqtt.Client("digi_mqtt_test") # Create instance of client with
client ID "digi_mqtt_test"
client.on_connect = on_connect # Define callback function for successful
connection
client.on_message = on_message # Define callback function for receipt of a
message
# client.connect("m2m.eclipse.org", 1883, 60) # Connect to (broker, port,
keepalive-time)
client.connect('127.0.0.1', 17300)

```

---

---

```
client.loop_forever() # Start networking daemon
```

---

**Note** You can easily copy and paste code from the [online version of this guide](#). Use caution with the PDF version, as it may not maintain essential indentations.

---

The first line imports the library functions for MQTT.

The functions **on\_connect** and **on\_message** are callback functions which are automatically called by the client upon connection to the broker and upon receiving a message, respectively.

The **on\_connect** function prints the result of the connection attempt, and performs the subscription. It is wise to do this in the callback function as it guarantees the attempt to subscribe happens only after the client is connected to the broker.

The **on\_message** function prints the received message when it comes in, as well as the topic it was published under.

In the body of the code, we:

- Instantiate a client object with the client ID **digi\_mqtt\_test**.
- Define the callback functions to use upon connection and upon message receipt.
- Connect to an MQTT broker at **m2m.eclipse.org**, on port **1883** (the default MQTT port, or 8883 for MQTT over SSL) with a keepalive of 60 seconds (this is how often the client pings the broker to keep the connection alive).

The last line starts a network daemon that runs in the background and handles data transactions and messages, as well as keeping the socket open, until the script ends.

## Use MQTT over the XBee Cellular Modem with a PC

To use this MQTT library over an XBee Smart Modem, you need a basic proxy that transfers a payload received via the MQTT client's socket to the serial or COM port that the XBee Smart Modem is active on, as well as the reverse; transfer of a payload received on the XBee Smart Modem's serial or COM port to the socket of the MQTT client. This is simplest with the XBee Smart Modem in Transparent mode, as it does not require code to parse or create API frames, and not using API frames means there is no need for them to be queued for processing.

1. To put the XBee Cellular Modem in Transparent mode, set **AP** to **0**.
2. Set **DL** to the IP address of the broker you want to use.
3. Set **DE** to the port to use, the default is 1883 (0x75B). This sets the XBee Smart Modem to communicate directly with the broker, and can be performed in XCTU as described in [Example: MQTT connect](#).
4. You can make the proxy with a dual-threaded Python script, a simple version follows:

---

```
import threading
import serial
import socket

def setup():
    """
    This function sets up the variables needed, including the serial port,
    and it's speed/port settings, listening socket, and localhost address.
    """
```

---

---

```

global clisock, cliaddr, svrsock, ser
# Change this to the COM port your XBee Cellular module is using. On
# Linux, this will be /dev/ttyUSB#
comport = 'COM44'
# This is the default serial communication speed of the XBee Cellular
# module
comspeed = 115200
buffer_size = 4096 # Default receive size in bytes
debug_on = 0 # Enables printing of debug messages
toval = None # Timeout value for serial port below
# Serial port object for XBCell modem
ser = serial.Serial(comport,comspeed,timeout=toval)
# Listening socket (accepts incoming connection)
svrsock = socket.socket(socket.AF_INET,socket.SOCK_STREAM)
# Allow address reuse on socket (eliminates some restart errors)
svrsock.setsockopt(socket.SOL_SOCKET, socket.SO_REUSEADDR, 1)
clisock = None
cliaddr = None # These are first defined before thread creation
addrtuple = ('127.0.0.1', 17300) # Address tuple for localhost
# Binds server socket to localhost (allows client program connection)
svrsock.bind(addrtuple)
svrsock.listen(1) # Allow (1) connection

def ComReaderThread():
    """
    This thread listens on the defined serial port object ('ser') for data
    from the modem, and upon receipt, sends it out to the client over the
    client socket ('clisock').
    """
    global clisock
    while (1):
        resp = ser.read() ## Read any available data from serial port
        print("Received {} bytes from modem.".format(len(resp)))

        clisock.sendall(resp) # Send RXd data out on client socket
        print("Sent {} byte payload out socket to client.".format(len
(resp)))

def SockReaderThread():
    """
    This thread listens to the MQTT client's socket and upon receiving a
    payload, it sends this data out on the defined serial port ('ser') to
    the
    modem for transmission.
    """
    global clisock
    while (1):
        data = clisock.recv(4096) # RX data from client socket
        # If the RECV call returns 0 bytes, the socket has closed
        if (len(data) == 0):
            print("ERROR - socket has closed. Exiting socket reader
thread.")
            return 1 # Exit the thread to avoid a loop of 0-byte receptions
        else:
            print("Received {} bytes from client via socket.".format(len
(data)))

```

---

```

        print("Sending payload to modem...")
        bytes_wr = ser.write(data) # Write payload to modem via
UART/serial
        print("Wrote {} bytes to modem".format(bytes_wr))

def main():
    setup() # Setup the serial port and socket
    global clisock, svrsock
    if (not clisock): # Accept a connection on 'svrsock' to open 'clisock'
        print("Awaiting ACCEPT on server sock...")
        (clisock,cliaddr) = svrsock.accept() # Accept an incoming
connection
        print("Connection accepted on socket")
        # Make thread for ComReader
        comthread = threading.Thread(target=ComReaderThread)
        comthread.start() # Start the thread
        # Make thread for SockReader
        sockthread = threading.Thread(target=SockReaderThread)
        sockthread.start() # Start the thread

    main()
    
```

**Note** This script is a general TCP-UART proxy, and can be used for other applications or scripts that use the TCP protocol. Its functionality is not limited to MQTT.

**Note** You can easily copy and paste code from the [online version of this guide](#). Use caution with the PDF version, as it may not maintain essential indentations.

This proxy script waits for an incoming connection on localhost (**127.0.0.1**), on port **17300**. After accepting a connection, and creating a socket for that connection (**clisock**), it creates two threads, one that reads the serial or COM port that the XBee Smart Modem is connected to, and one that reads the socket (**clisock**), that the MQTT client is connected to.

With:

- The proxy script running
- The MQTT client connected to the proxy script via localhost (**127.0.0.1**)
- The XBee Smart Modem connected to the machine via USB and properly powered
- **AP**, **DL**, and **DE** set correctly

the proxy acts as an intermediary between the MQTT client and the XBee Smart Modem, allowing the MQTT client to use the data connection provided by the device.

Think of the proxy script as a translator between the MQTT client and the XBee Smart Modem. The following figure shows the basic operation.

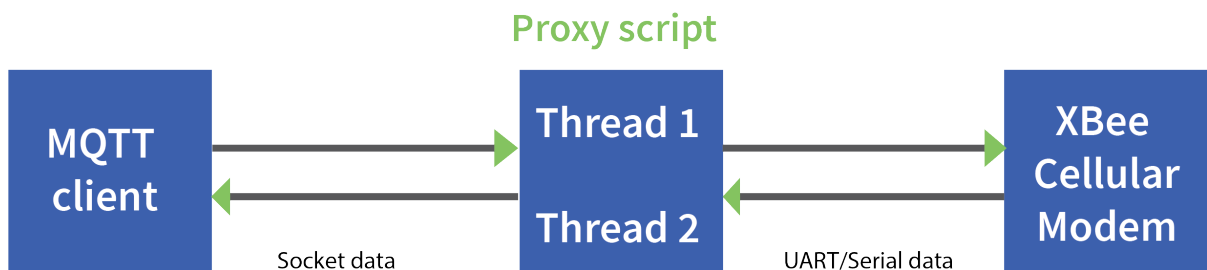

The thread that reads the serial port forwards any data received onward to the client socket, and the thread reading the client socket forwards any data received onward to the serial port. This is represented in the figure above.

The proxy script needs to be running before running an MQTT publish or subscribe script.

1. With the proxy script running, run the subscribe example from [Example: receive messages \(subscribe\) with MQTT](#), but change the connect line from `client.connect("m2m.eclipse.org", 1883, 60)` to `client.connect("127.0.0.1", port=17300, keepalive=20)`. This connects the MQTT client to the proxy script, which in turn connects to a broker via the XBee Smart Modem's internet connection.
2. Run the publish example from [Example: send messages \(publish\) with MQTT](#) in a third Python instance (while the publish script is running you will have three Python scripts running at the same time).

The publish script runs over your computer's normal Internet connection, and does not use the XBee Smart Modem. You are able to see your published message appear in the subscribe script's output once it is received from the broker via the XBee Smart Modem. If you watch the output of the proxy script during this process you can see the receptions and transmissions taking place.

The proxy script must be running before you run the subscribe and publish scripts. If you stop the subscribe script, the socket closes, and the proxy script shows an error. If you try to start the proxy script after starting the subscribe script, you may also see a socket error. To avoid these errors, it is best to start the scripts in the correct order: proxy, then subscribe, then publish.



## Debugging

If you experience problems with the settings in the examples, you can load the default settings in XCTU.

---

**Note** If you load the default settings, you will need to reapply any configuration settings that you have previously made.

---

1. On the Configuration toolbar, click the **Default** button  to load the default values established by the firmware, and click **Yes** to confirm.
2. Factory settings are loaded but not written to the device. To write them, click the **Write** button  on the toolbar.

## Software libraries

One way to communicate with the XBee device is by using a software library. The libraries available for use with the XBee Smart Modem include:

- [XBee Java library](#)
- [XBee Python library](#)

The XBee Java Library is a Java API. The package includes the XBee library, its source code and a collection of samples that help you develop Java applications to communicate with your XBee devices.

The XBee Python Library is a Python API that dramatically reduces the time to market of XBee projects developed in Python and facilitates the development of these types of applications, making it an easy process.



## Get started with MicroPython

---

This section provides an overview and simple examples of how to use MicroPython with the XBee Smart Modem. You can use MicroPython to enhance the intelligence of the XBee to enable you to do edge-computing by adding business logic in MicroPython, rather than using external components.

**Note** For in-depth information and more complex code examples, refer to the [Digi MicroPython Programming Guide](#).

---

About MicroPython .....	58
MicroPython on the XBee Smart Modem .....	58
Use XCTU to enter the MicroPython environment .....	58
Use the MicroPython Terminal in XCTU .....	59
Example: hello world .....	59
Example: turn on an LED .....	59
Example: debug the secondary UART .....	60
Exit MicroPython mode .....	61
Other terminal programs .....	61
Use picocom in Linux .....	63

## About MicroPython

MicroPython is an open-source programming language based on Python 3, with much of the same syntax and functionality, but modified to fit on small devices with limited hardware resources, such as microcontrollers, or in this case, a cellular modem.

### Why use MicroPython

MicroPython enables on-board intelligence for simple sensor or actuator applications using digital and analog I/O. MicroPython can help manage battery life. Cryptic readings can be transformed into useful data, excess transmissions can be intelligently filtered out, modern sensors and actuators can be employed directly, and logic can glue inputs and outputs together in an intelligent way.

For more information about MicroPython, see [www.micropython.org](http://www.micropython.org).

For more information about Python, see [www.python.org](http://www.python.org).

## MicroPython on the XBee Smart Modem

The XBee Smart Modem has MicroPython running on the device itself. You can access a MicroPython prompt from the XBee Smart Modem when you install it in an appropriate development board (XBDB or XBIB), and connect it to a computer via a USB cable.

---

**Note** MicroPython does not work with SPI.

---

The examples in this guide assume:

- You have [XCTU](#) on your computer. See [Configure the device using XCTU](#).
- You have a terminal program installed on your computer. We recommend using the [Use the MicroPython Terminal in XCTU](#). This requires XCTU 6.3.7 or higher.
- You have an XBee Smart Modem installed in an appropriate development board such as an XBIB-U-DEV.

---



**Note** Most examples in this guide require the XBIB-U-DEV board.

---

- The XBee Smart Modem is connected to the computer via a USB cable and XCTU recognizes it.
- The board is powered by an appropriate power supply, 12 VDC and at least 1.1 A.

## Use XCTU to enter the MicroPython environment



To use the XBee Smart Modem in the MicroPython environment:

1. Use XCTU to add the device(s); see [Configure the device using XCTU](#) and [Add a device](#).
2. The XBee Smart Modem appears as a box in the **Radio Modules** information panel. Each module displays identifying information about itself.
3. Click this box to select the device and load its current settings.
4. Set the device's baud rate to 115200 b/s, in the **BD** field select **115200 [7]** or higher and click the **Write** button . We recommend using flow control to avoid data loss, especially when pasting large amounts of code/text.
5. Put the XBee Smart Modem into MicroPython mode, in the **AP** field select **MicroPython REPL [4]** and click the **Write** button .

6. Note what COM port(s) the XBee Smart Modem is using, because you will need this information when you use terminal communication. The **Radio Modules** information panel lists the COM port in use.

## Use the MicroPython Terminal in XCTU

You can use the MicroPython Terminal to communicate with the XBee Smart Modem when it is in MicroPython mode.<sup>1</sup> This requires XCTU 6.3.7 or higher. To enter MicroPython mode, follow the steps in [Use XCTU to enter the MicroPython environment](#). To use the MicroPython Terminal:

1. Click the **Tools** drop-down menu  and select **MicroPython Terminal**. The terminal opens.
2. Click **Open**. If you have not already added devices to XCTU:
  - a. In the **Select the Serial/USB port** area, click the COM port that the device uses.
  - b. Verify that the baud rate and other settings are correct.
3. Click **OK**. The **Open** icon changes to **Close** , indicating that the device is properly connected.
4. Press **Ctrl+B** to get the MicroPython version banner and prompt.

You can now type or paste MicroPython commands at the `>>>` prompt.

## Troubleshooting

If you receive **No such port: 'Port is already in use by other applications.'** in the **MicroPython Terminal** close any other console sessions open inside XCTU and close any other serial terminal programs connected to the device, then retry the MicroPython connection in XCTU.

If the device seems unresponsive, try pressing **Ctrl+C** to end any running programs.

You can use the **+++** escape sequence and look for an **OK** for confirmation that you have the correct baud rate.

## Example: hello world

Before you begin, you must have previously added a device in XCTU. See [Add a device](#).

1. At the MicroPython `>>>` prompt, type the Python command: `print("Hello, World!")`
2. Press **Enter** to execute the command. The terminal echos back **Hello, World!**.

## Example: turn on an LED

1. Note the **DS4** LED on the XBIB board. The following image highlights it in a red box. The LED is normally off.

---

<sup>1</sup>See [Other terminal programs](#) if you do not use the MicroPython Terminal in XCTU.

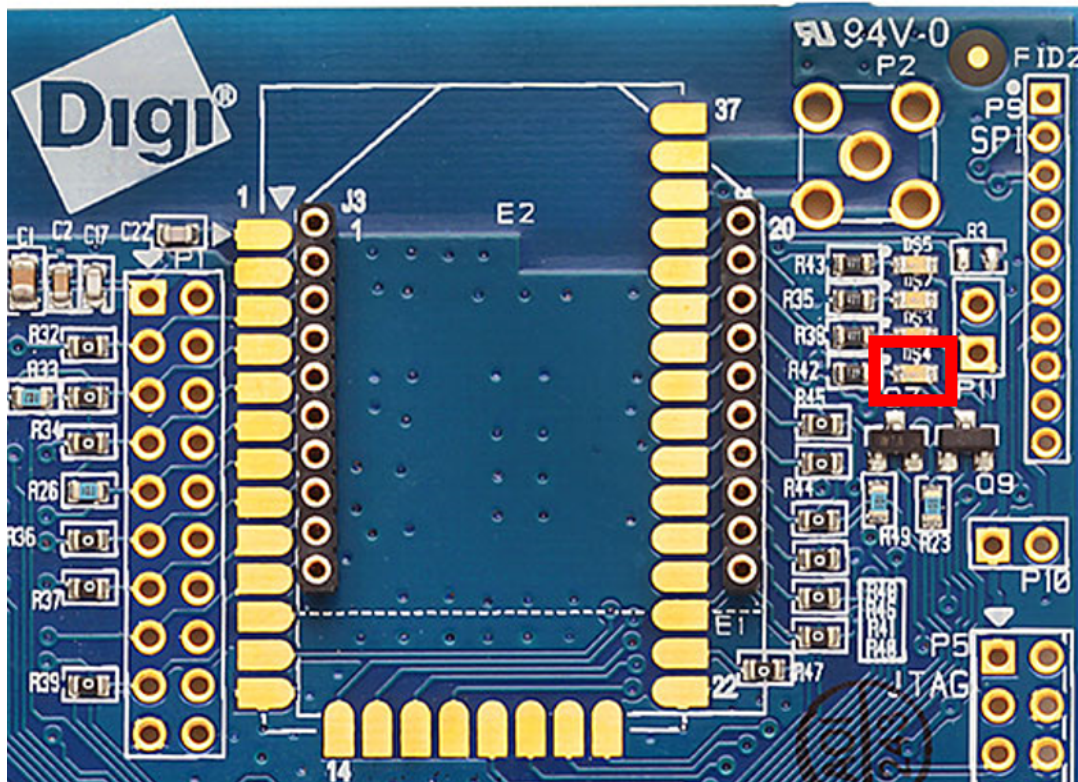

- At the MicroPython >>> prompt, type the commands below, pressing **Enter** after each one. After entering the last line of code, the LED illuminates. Anything after a # symbol is a comment, and you do not need to type it.

**Note** You can easily copy and paste code from the [online version of this guide](#). Use caution with the PDF version, as it may not maintain essential indentations.

```
import machine
from machine import Pin
led = Pin("D4", Pin.OUT, value=0) # Makes a pin object set to output 0.
# One might expect 0 to mean OFF and 1 to mean ON, and this is normally the
# case.
# But the LED we are turning on and off is setup as what is# known as
"active low".
# This means setting the pin to 0 allows current to flow through the LED and
then through the pin, to ground.
```

- To turn it off, type the following and press **Enter**:

```
led.value(1)
```

You have successfully controlled an LED on the board using basic I/O.

## Example: debug the secondary UART

This sample code is handy for debugging the secondary UART. It simply relays data between the primary and secondary UARTs.

---

```

from machine import UART
import sys, time

def uart_init():
    u = UART(1)
    u.write('Testing from XBee\n')
    return u

def uart_relay(u):
    while True:
        uart_data = u.read(-1)
        if uart_data:
            sys.stdout.buffer.write(uart_data)
            stdin_data = sys.stdin.buffer.read(-1)
            if stdin_data:
                u.write(stdin_data)

        time.sleep_ms(5)

u = uart_init()
uart_relay(u)

```

---

You only need to call **uart\_init()** once.



Call **uart\_relay()** to pass data between the UARTs.

Send **Ctrl-C** to exit relay mode.

When done, call **u.close()** to close the secondary UART.

## Exit MicroPython mode

To exit MicroPython mode:

1. In the XCTU MicroPython Terminal, click the green **Close** button .
2. Click **Close** at the bottom of the terminal to exit the terminal.
3. In XCTU's Configuration working mode , change **AP API Enable** to another mode and click the **Write** button . We recommend changing to Transparent mode **[0]**, as most of the examples use this mode.

## Other terminal programs

If you do not use the MicroPython Terminal in XCTU, you can use other terminal programs to communicate with the XBee Smart Modem. If you use Microsoft Windows, follow the instructions for Tera Term, if you use Linux, follow the instructions for picocom. To download these programs:

- Tera Term for Windows; see <https://tssh2.osdn.jp/index.html.en>.
- Picocom for Linux; see [https://developer.ridgerun.com/wiki/index.php/Setting\\_up\\_Picocom\\_-\\_Ubuntu](https://developer.ridgerun.com/wiki/index.php/Setting_up_Picocom_-_Ubuntu) and for the source code and in-depth information <https://github.com/npat-efault/picocom>.

## Tera Term for Windows

With the XBee Smart Modem in MicroPython mode (**AP = 4**), you can access the MicroPython prompt using a terminal.

1. Open Tera Term. The **Tera Term: New connection** window appears.
2. Click the **Serial** radio button to select a serial connection.
3. From the **Port:** drop-down menu, select the COM port that the XBee Smart Modem is connected to.
4. Click **OK**. The **COMxx - Tera Term VT** terminal window appears and Tera Term attempts to connect to the device at a baud rate of 9600 b/s. The terminal will not allow communication with the device since the baud rate setting is incorrect. You must change this rate as it was previously set to 115200 b/s.
5. Click **Setup** and **Serial Port**. The **Tera Term: Serial port setup** window appears.

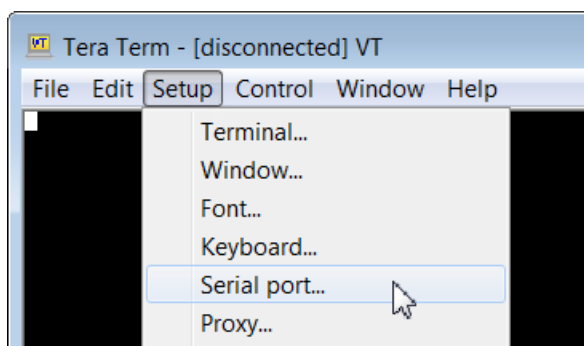

6. In the **Tera Term: Serial port setup** window, set the parameters to the following values:
  - **Port:** Shows the port that the XBee Smart Modem is connected on.
  - **Baud rate:** 115200
  - **Data:** 8 bit
  - **Parity:** none
  - **Stop:** 1 bit
  - **Flow control:** hardware
  - **Transmit delay:** N/A
7. Click **OK** to apply the changes to the serial port settings. The settings should go into effect right away.
8. To verify that local echo is not enabled and that extra line-feeds are not enabled:
  - a. In Tera Term, click **Setup** and select **Terminal**.
  - b. In the **New-line** area of the **Tera Term: Serial port setup** window, click the **Receive** drop-down menu and select **CR** if it does not already show that value.
  - c. Make sure the **Local echo** box is not checked.
9. Click **OK**.
10. Press **Ctrl+B** to get the MicroPython version banner and prompt.

```
MicroPython v1.8.7 on 2017-04-06; XBee Cellular with EFM32G
Type "help()" for more information.
>>>
```

Now you can type MicroPython commands at the `>>>` prompt.

## Use picocom in Linux

With the XBee Smart Modem in MicroPython mode (**AP = 4**), you can access the MicroPython prompt using a terminal.

---

**Note** The user must have read and write permission for the serial port the XBee Smart Modem is connected to in order to communicate with the device.

---

1. Open a terminal in Linux and type **picocom -b 115200 /dev/ttyUSB0**. This assumes you have no other USB-to-serial devices attached to the system.
2. Press **Ctrl+B** to get the MicroPython version banner and prompt. You can also press **Enter** to bring up the prompt.

If you do have other USB-to-serial devices attached:

1. Before attaching the XBee Smart Modem, check the directory **/dev/** for any devices named **ttUSBx**, where **x** is a number. An easy way to list these is to type: **ls /dev/ttyUSB\***. This produces a list of any device with a name that starts with **ttUSB**.
2. Take note of the devices present with that name, and then connect the XBee Smart Modem.
3. Check the directory again and you should see one additional device, which is the XBee Smart Modem.
4. In this case, replace **/dev/ttyUSB0** at the top with **/dev/ttyUSB<number>**, where **<number>** is the new number that appeared.
5. It should connect and show Terminal ready.

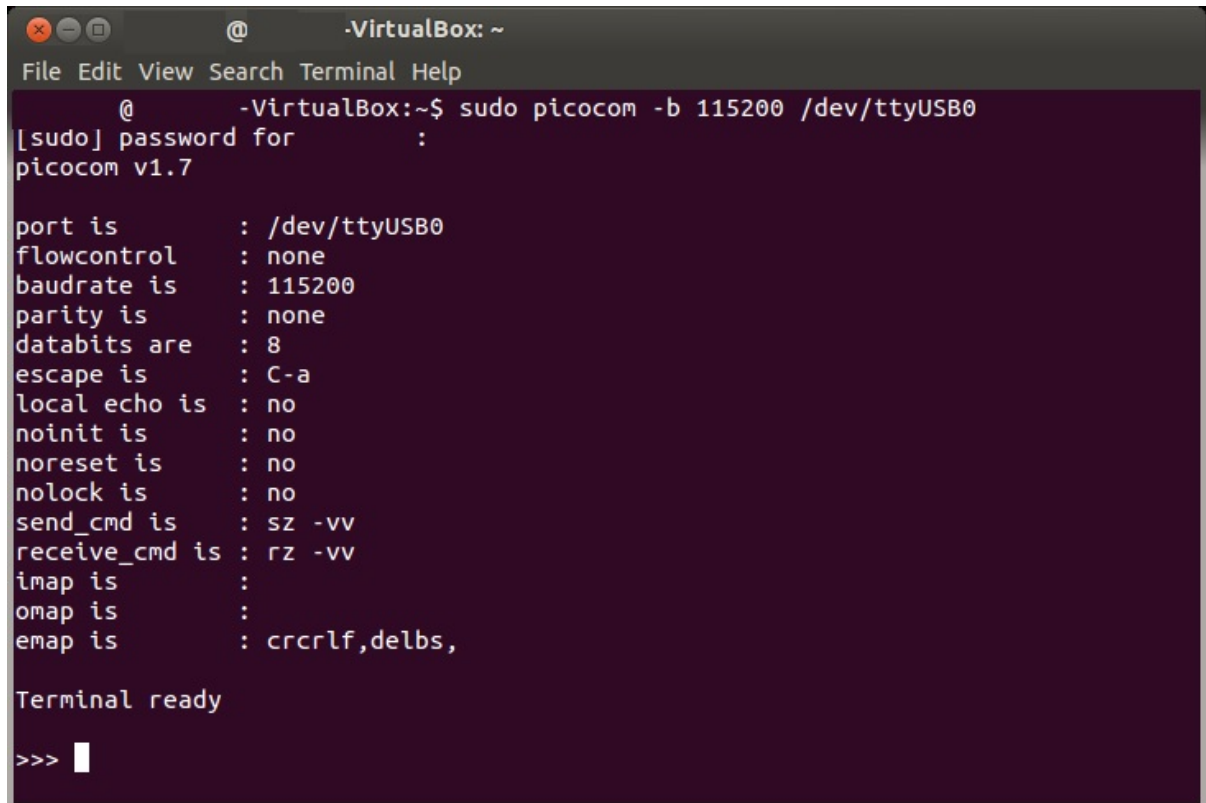

```
-VirtualBox: ~
File Edit View Search Terminal Help
@ -VirtualBox:~$ sudo picocom -b 115200 /dev/ttyUSB0
[sudo] password for :
picocom v1.7

port is      : /dev/ttyUSB0
flowcontrol  : none
baudrate is  : 115200
parity is    : none
databits are : 8
escape is    : C-a
local echo is : no
noinit is    : no
noreset is   : no
nolock is    : no
send_cmd is  : SZ -vv
receive_cmd is : rZ -vv
imap is      :
omap is      :
emap is      : crclrf,delbs,

Terminal ready

>>> █
```

Now you can type MicroPython commands at the >>> prompt.



## Get started with BLE

---

BLE (**Bluetooth**<sup>®</sup> Low Energy) is an RF protocol that enables you to connect your XBee device to another device. Both devices must have BLE enabled.

For example, you can use your cellphone to connect to and configure your XBee device.

### Enable BLE on an XBee device

This process explains how to enable BLE on your XBee3 device and verify the connection.

1. Set up your XBee device, and make sure to connect the BLE antenna to the device. See [Get started with the XBee Smart Modem Development Kit](#).
2. [Enable BLE and configure the BLE password using XCTU](#).
3. [Get the Digi XBee Mobile phone application](#).
4. [Connect with BLE and configure your XBee device](#).

---

**Note** The BLE protocol is disabled on the XBee device by default. You can create a custom factory default configuration that ensures BLE is always enabled. See [Custom configuration: Create a new factory default](#).

---

### Enable BLE and configure the BLE password using XCTU

Some of the latest XBee3 modules support Bluetooth Low Energy (BLE) as an extra interface for configuration. If you want to use this feature, you have to enable BLE. You must also enable security by setting a BLE password on the XBee device in order to connect, configure, or send data over BLE.

The BLE password is configured using XCTU. Make sure you have installed or updated XCTU to version 6.4.2. or later. Earlier versions of XCTU do not include the BLE configuration features. See [Download and install XCTU](#) for installation instructions.

Before you begin, you should determine the password you want to use for BLE on the XBee device and store it in a secure place. Digi recommends a secure password of at least 8 characters and a random combination of letters, numbers, and special characters. Digi also recommends using a security management tool such as LastPass or Keepass for generating and storing passwords for many devices.

---

**Note** When you enter the BLE password in XCTU, the salt and verifier values are calculated as you set your password. For more information on how these values are used in the authentication process, see [BLE Unlock API - 0x2C](#).

---

1. Launch XCTU .

2. Switch to Configuration working mode .
3. Select a BLE compatible radio module from the device list.
4. In the Bluetooth Options section, select **Enabled[1]** from the **BT Bluetooth Enable** command drop-down.

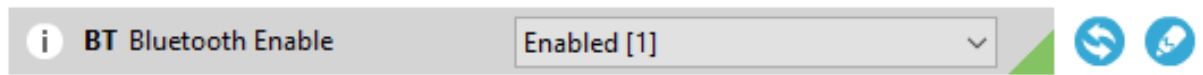

5. Click the **Write setting** button . The **Bluetooth authentication not set** dialog appears.

**Note** If BLE has been previously configured, the **Bluetooth authentication not set** dialog does not appear. If this happens, click **Configure** in the Bluetooth Options section to display the **Configure Bluetooth Authentication** dialog.

6. Click **Configure** in the dialog. The **Configure Bluetooth Authentication** dialog appears.

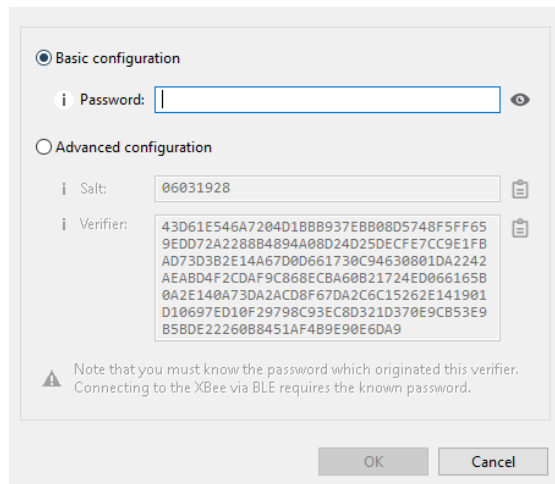

7. In the **Password** field, type the password for the device. As you type, the **Salt** and **Verifier** fields are automatically calculated and populated in the dialog as shown above. Make a note of the password, as this password is used when you connect to this XBee device via BLE using the [Digi XBee Mobile app](#).
8. Click **OK** to save the configuration.

## Get the Digi XBee Mobile phone application

To see the nearby devices that have BLE enabled, you must get the free Digi XBee Mobile application from the iOS App Store or Google Play and downloaded to your phone.

1. On your phone, go to the App store.
2. Search for **Digi XBee Mobile**.
3. Download and install the application.

The Digi XBee Mobile application is compatible with the following operating systems and versions:

- Android 5.0 or higher
- iOS 11 or higher

## Connect with BLE and configure your XBee device

You can use the Digi XBee Mobile application to verify that BLE is enabled on your XBee device.

1. [Get the Digi XBee Mobile phone application](#).
2. Open the Digi XBee Mobile application. The **Find XBee devices** screen appears and the app automatically begins scanning for devices. All nearby devices with BLE enabled are displayed in a list.
3. Scroll through the list to find your XBee device.

The first time you open the app on a phone and scan for devices, the device list contains only the name of the device and the BLE signal strength. No identifying information for the device displays. After you have authenticated the device, the device information is cached on the phone. The next time the app on this phone connects to the XBee device, the IMEI for the device displays in the app device list.

---

**Note** The IMEI is derived from the SH and SL values.

---

4. Tap the XBee device name in the list. A password dialog appears.
5. Enter the [password](#) you previously configured for the device in XCTU.
6. Tap **OK**. The **Device Information** screen displays. You can now scroll through the settings for the XBee device and change the device's configuration as needed.

## BLE reference

### BLE advertising behavior and services

When the Bluetooth radio is enabled, periodic BLE advertisements are transmitted. The advertisement data includes the product name. When an XBee device connects to the Bluetooth radio, the BLE services are listed:

- [Device Information Service](#)
- [XBee API BLE Service](#)

### Device Information Service

The standard Device Information Service is used. The Manufacturer, Model, and Firmware Revision characters are provided inside the service.

## XBee API BLE Service

You can configure the XBee through the BLE interface using API frame requests and responses. The API frame format through Bluetooth is equivalent to setting AP=1 and transmitting the frames over the UART or SPI interface. API frames can be executed over Bluetooth regardless of the AP setting.

The BLE interface allows these frames:

- [BLE Unlock API - 0x2C](#)
- [BLE Unlock Response - 0xAC](#)
- [AT Command - 0x08](#)

This API reference assumes that you are familiar with Bluetooth and GATT services. The specifications for Bluetooth are an open standard and can be found at the following links:

- Bluetooth Core Specifications: <https://www.bluetooth.com/specifications/bluetooth-core-specification>
- Bluetooth GATT: <https://www.bluetooth.com/specifications/gatt/generic-attributes-overview>

The XBee API GATT Service contains two characteristics: the API Request characteristic and the API Response characteristic. The UUIDs for the service and its characteristics are listed in the table below.

Characteristic	UUID
API Service UUID	53da53b9-0447-425a-b9ea-9837505eb59a
<a href="#">API Request Characteristic UUID</a>	7dddca00-3e05-4651-9254-44074792c590
<a href="#">API Response Characteristic UUID</a>	f9279ee9-2cd0-410c-81cc-adf11e4e5aea

### API Request characteristic

**UUID:** 7dddca00-3e05-4651-9254-44074792c590

**Permissions:** Writeable

XBee API frames are broken into chunks and transmitted sequentially to the request characteristic using write operations. Valid frames will then be processed and the result will be returned through indications on the response characteristic.

API frames do not need to be written completely in a single write operation to the request characteristic. In fact, Bluetooth limits the size of a written value to 3 bytes smaller than the configured MTU (Maximum Transmission Unit), which defaults to 23, meaning that by default, you can only write 20 bytes at a time.

You must bond with the XBee in order to write to this characteristic. If you do not bond before writing, you will receive errors when attempting to write.

After connecting and bonding, you must send a valid [Bluetooth Unlock API Frame](#) in order to authenticate the connection. If the Bluetooth Unlock API Frame has not been executed, all other API frames will be silently ignored and not processed.

### API Response characteristic

**UUID:** f9279ee9-2cd0-410c-81cc-adf11e4e5aea

**Permissions:** Readable, Indicate

Responses to API requests made to the request characteristic will be returned through the response characteristics. This characteristic cannot be read directly.

Response data will be presented through indications on this characteristic. Indications are acknowledged and re-transmitted at the BLE link layer and application layer and provides a robust transport for this data.

## Get started with Digi Remote Manager

---

Digi Remote Manager® is a cloud-based device and data management platform that you can use to configure and update a device, and view and manage device data.

**Note** Digi Remote Manager requires TCP and will not work with NB-IoT, unless the carrier supports TCP.

---

The sections below describe how to create a Remote Manager account, upgrading your device, configure your device, and manage data in Remote Manager.

1. [Create a Remote Manager account and add devices](#)
2. To ensure that all Remote Manager features are available, you should upgrade your device to the latest firmware. See [Update the firmware from Remote Manager](#) or [Update the firmware using web services in Remote Manager](#).
3. Configure your device in Remote Manager  
To be able to configure your device in Remote Manager, the device must be connected to Remote Manager. You can connect to and configure your device in Remote Manager using one of the following methods:
  - **Scheduled connection:** In this method, you create a list of tasks that you want to perform on the device, and then start the operation. This is the recommended method, and is the best choice for low data usage. See [Configure Remote Manager features by scheduling tasks](#).
  - **Always connected:** This method can be used for initial configuration, or when you are not concerned with low data usage. See [Configure XBee settings within Remote Manager](#).
4. [Secure the connection between an XBee and Remote Manager with server authentication](#).
5. [Manage data in Remote Manager](#)
6. [Remote Manager reference](#)

### Create a Remote Manager account and add devices

To be able to use Remote Manager, you must create a Remote Manager account and add your XBee devices to the device list. You should also verify that the device is enabled to connect to Remote Manager.

1. [Create a Remote Manager account.](#)
2. [Add an XBee Smart Modem to Remote Manager.](#)
3. [Verify the connection between a device and Remote Manager](#)

## Create a Remote Manager account

Digi Remote Manager is an on-demand service with no infrastructure requirements. Remote devices and enterprise business applications connect to Remote Manager through standards-based web services. This section describes how to configure and manage an XBee using Remote Manager. For detailed information on using Remote Manager, refer to the [Remote Manager User Guide](#), available via the **Documentation** tab in Remote Manager.

---

**Note** Digi Remote Manager requires TCP and will not work with NB-IoT, unless the carrier supports TCP.

---

Before you can manage an XBee with Remote Manager, you must create a Remote Manager account. To create a Remote Manager account:

1. Go to <https://www.digi.com/products/cloud/digi-remote-manager>.
2. Click **30 DAY FREE TRIAL/LOGIN**.
3. Follow the online instructions to complete account registration. You can upgrade your Developer account to a paid account at any time.

When you are ready to deploy multiple XBee Smart Modems in the field, upgrade your account to access additional Remote Manager features.

## Add an XBee Smart Modem to Remote Manager

Each XBee Smart Modem must be added to the Remote Manager account inventory list.

Before adding an XBee to your Remote Manager account inventory, you need to determine the International Mobile Equipment Identity (IMEI) number for the device. Use XCTU to view the IMEI number by querying the **IM parameter**.

---

**Note** Digi Remote Manager requires TCP and will not work with NB-IoT, unless the carrier supports TCP.

---

To add an XBee to your Remote Manager account inventory, follow these steps:

1. [Log into Remote Manager.](#)
2. Click **Device Management > Devices**.
3. Click **Add Devices**. The **Add Devices** dialog appears.
4. Select **IMEI #**, and type or paste the IMEI number of the XBee you want to add. The **IM (IMEI)** command provides this number.

**Add Devices**

For each device you want to add:

- Enter the device MAC address. Or, if there is no MAC address, enter the IMEI number or device ID.
- If the device requires an installation code, enter the installation code.
- Click Add.
- When you are finished adding devices, click OK.

[Click here](#) for details.

IMEI #:

Install Code:

MAC Address	Device ID	Install Code	Remove
No devices to add			

- Click **Add** to add the device. The XBee is added to your inventory.
- Click **OK** to close the **Add Devices** dialog and return to the **Devices** view.

## Verify the connection between a device and Remote Manager

By default, the XBee is configured to enable a connection to Remote Manager. The connection between XBee and Remote Manager is maintained using periodic UDP operations.

You should verify the default settings to ensure that the connection will work as desired.

- Launch XCTU .
- Verify that the **MO command** is set to **6**, which is the default.
- Configure the frequency of polls for Remote Manager activity using the **DF command**. The default is 1440 minutes (24 hours).
- Enable the SM/UDP feature in Remote Manager for each device. See [Enable SM/UDP](#).

## Configure Remote Manager features by scheduling tasks

Remote Manager provides tools to perform common management and maintenance tasks on your XBee device. A Remote Manager task is a sequence of commands that can be performed on one or more XBee Cellular devices. Tasks can then be assigned to a schedule. When a scheduled task is run it becomes an active operation and can be monitored for status and completion.

**Note** You must upgrade your device to the latest firmware for this feature to be available. See [Update the firmware from Remote Manager](#) or [Update the firmware using web services in Remote Manager](#).

Some typical examples of useful things that can be done with scheduled tasks include:

- Change configuration
- Update your MicroPython application and libraries to add features and capabilities
- Update your security certificates
- Perform a data service device request
- Send an SMS message to your device

Scheduled tasks can be created and performed through the following methods:



- Remote Manager **Schedules** user interface.
- Remote Manager **API Explorer** user interface
- Programming web service calls

---

**Note** For any of these methods to work properly, you must have SM/UDP enabled. See [Enable SM/UDP](#).

---

## Overview: Create a schedule for a set of tasks

When using the [most current firmware version](#), the XBee Cellular devices are designed to poll Remote Manager once per day over the SM/UDP protocol to check for any active operations. In order to perform a set of tasks, the device needs to be told to connect to Remote Manager, perform the sequence of tasks, and then told to disconnect.

The following provides a template of how to create a schedule for an XBee to connect, perform a set of tasks and then disconnect:

1. Make sure that SM/UDP is enabled. See [Enable SM/UDP](#).
2. [Log into Remote Manager](#).
3. Click **Device Management > Schedules**.
4. Click **New Schedule**. The **New Schedule** page displays.

---

**Note** The **Steps to schedule a task** wizard may display. Click the **x** in the upper left corner to close the wizard. See [Schedule walk-through feature](#) in the *Digi Remote Manager® User Guide* for more information.

---

5. In the **Description** field, enter a name for the schedule, such "Read Settings."
6. Add the following tasks:
  - a. Click **SM/UDP > SM/UDP Request Connect**. A task is added to the dialog.
  - b. Add other tasks as needed. For examples, refer to the [Examples](#) section.
  - c. Click **Device > Disconnect**. A task is added to the dialog.
7. Click **Schedule** in the lower right corner of the dialog to schedule the tasks to run. The schedule screen displays.

---

**Note** You can also click **Save as** to save this schedule for future use.

---

8. Select the device(s) on which you want to run this schedule. You can add more than one device.
9. Click **Run Now**.

## Examples

The examples in the following sections assume you are using the Digi Remote Manager Schedule wizard. However, you should be aware that operations can be created and performed programmatically via web service calls or via the API explorer. The XML web service calls provide more options than are available in the GUI dashboard for some tasks.

### Example: Read settings and state using Remote Manager

In order to configure devices you will need to know the structure of the XML for your XBee's settings. The easiest way to obtain this is to perform a `query_setting` RCI request against your device.

---

**Note** You must upgrade your device to the latest firmware for this feature to be available. See [Update the firmware from Remote Manager](#) or [Update the firmware using web services in Remote Manager](#).

---

**Note** To obtain the state of the device, you can perform the same operations in the example below, but replace `query_setting` with `query_state`.

---

1. [Log into Remote Manager](#).
2. Click **Device Management > Schedules**.
3. Click **New Schedule**. The **New Schedule** page displays.

---

**Note** The **Steps to schedule a task** wizard may display. Click the **x** in the upper left corner to close the wizard. See [Schedule walk-through feature](#) in the *Digi Remote Manager® User Guide* for more information.

---

4. In the **Description** field, enter a name for the schedule, such "Read Settings."
5. Add the following tasks:
  - a. Click **SM/UDP > SM/UPD Request Connect**. A task is added to the dialog.
  - b. Click **Device > RCI Command**. A task is added to the dialog.

Change the RCI command to the following:

---

```
<rci_request>
  <query_setting/>
</rci_request>
```

---

- c. Click **Device > Disconnect**. A task is added to the dialog.
6. Click **Schedule** in the lower right corner of the dialog to schedule the tasks to run. The schedule screen displays.

---

**Note** You can also click **Save as** to save this schedule for future use.

---

7. Select the device(s) on which you want to run this schedule. You can add more than one device.
8. Click **Run Now**.
9. Click **Device Management > Operations** to view information about the operation. See [Operations](#) in the *Digi Remote Manager® User Guide* for more information about this page.

After your operation completes you can click **Response** to view the XML for all of the settings that your XBee reports. This XML structure has the same settings that you will use in the `set_setting` command to configure your XBee as shown in this example: [Example: Configure a device from Remote Manager using XML](#).

## Example: Configure a device from Remote Manager using XML

You can configure each XBee device from Remote Manager, using XML. The devices must be in the Remote Manager inventory device list and be active.

---

**Note** You must upgrade your device to the latest firmware for this feature to be available. See [Update the firmware from Remote Manager](#) or [Update the firmware using web services in Remote Manager](#).

---

---

**Note** Digi Remote Manager requires TCP and will not work with NB-IoT, unless the carrier supports TCP.

---

In this configuration example, you are changing the device to poll four times a day instead of just once. In this case, you should change the **DF** parameter to 360 minutes.

1. [Log into Remote Manager](#).
2. Click **Device Management > Schedules**.
3. Click **New Schedule**. The **New Schedule** page displays.

---

**Note** The **Steps to schedule a task** wizard may display. Click the **x** in the upper left corner to close the wizard. See [Schedule walk-through feature](#) in the *Digi Remote Manager® User Guide* for more information.

---

4. In the **Description** field, enter a name for the schedule, such as "Configure Reporting Frequency."
5. Add the following tasks:
  - a. Click **SM/UDP > SM/UPD Request Connect**. A task is added to the dialog.
  - b. Click **Device > RCI Command**. A task is added to the dialog.

Change the RCI command to the following:

---

```
<rci_request>
  <set_setting>
    <remote_manager>
      <DF>360</DF>
    </remote_manager>
  </set_setting>
</rci_request>
```

---

- c. Click **Device > Disconnect**. A task is added to the dialog.
6. Click **Schedule** in the lower right corner of the dialog to schedule the tasks to run. The schedule screen displays.

---

**Note** You can also click **Save as** to save this schedule for future use.

---

7. Select the device(s) on which you want to run this schedule. You can add more than one device.
8. Click **Run Now**.
9. Click **Device Management > Operations** to view information about the operation. See [Operations](#) in the *Digi Remote Manager® User Guide* for more information about this page.

## Example: Update XBee firmware using Remote Manager

You can use a scheduled task to update the XBee Cellular firmware. Since the device is configured by default to poll Remote Manager once a day, you need to be able to set up a scheduled task to update the device's firmware to take advantage of new features and fixes. To update the firmware to a new version you will need to obtain the .gbl file for the new firmware from our support site. This file is one of the files in the .zip (for example, XBXC-31011.zip) archive that you can download for the product.

---

**Note** You must upgrade your device to the latest firmware for this feature to be available. See [Update the firmware from Remote Manager](#) or [Update the firmware using web services in Remote Manager](#).

---

**Note** Digi Remote Manager requires TCP and will not work with NB-IoT, unless the carrier supports TCP.

---

To upgrade using a scheduled task perform the following steps:

Step 1:

1. Download the updated firmware file for your device from Digi's support site.
  - a. Go to the [Digi XBee3 Cellular LTE-M support page](#).
  - b. Scroll down to the **Firmware Updates** section.
  - c. Locate and click **Digi XBee3 Cellular LTE-M/NB-IoT Gating Firmware** to download the zip file. If you have already upgraded past the gating firmware, click **XBee Cellular LET-M/NB-IoT Firmware** to download the zip file.
  - d. Unzip the file. The file contains either a .ebin or a .gbl file.
2. [Log into Remote Manager](#).
3. Make sure that you have enabled SM/UDP. See [Enable SM/UDP](#).
4. Click **Device Management > Schedules**.
5. Click **New Schedule**. The **New Schedule** page displays.

---

**Note** The **Steps to schedule a task** wizard may display. Click the **x** in the upper left corner to close the wizard. See [Schedule walk-through feature](#) in the *Digi Remote Manager® User Guide* for more information.

---

6. In the **Description** field, enter a name for the schedule, such as "Update XBee Firmware."
7. Add the following tasks:
  - a. Click **SM/UDP > SM/UDP Request Connect**. A task is added to the dialog.
  - b. Click **Device > Gateway Firmware Update**.
  - c. Click **Browse** and select the .gbl file (for example, XBXC-11411.gbl) for the new firmware to update.
  - d. Click **Device > Disconnect**. A task is added to the dialog.
8. Click **Schedule** in the lower right corner of the dialog to schedule the tasks to run. The schedule screen displays.

---

**Note** You can also click **Save as** to save this schedule for future use.

---

9. Select the device(s) on which you want to run this schedule. You can add more than one device.
10. Click **Run Now**.
11. Click **Device Management > Operations** to view information about the operation. See [Operations](#) in the *Digi Remote Manager® User Guide* for more information about this page.

## Example: Update MicroPython from Remote Manager using XML

You can use the API Explorer in Remote Manager to create a schedule that enables you to update the MicroPython application. In this example, you want to add FTP client capability to the MicroPython application. You will need to add the library *uftp.py* and then update the *main.py* application.

This example is done following these steps: [upload the MicroPython files](#) to Remote Manager, [create an XML file](#) with the tasks that you want to perform, [upload the XML file](#), and then [schedule an operation](#) to upload the files onto your device.

---

**Note** You must upgrade your device to the latest firmware for this feature to be available. See [Update the firmware from Remote Manager](#) or [Update the firmware using web services in Remote Manager](#).

---

**Note** Digi Remote Manager requires TCP and will not work with NB-IoT, unless the carrier supports TCP.

---

### Step 1: Upload the MicroPython files

1. [Log into Remote Manager](#).
2. Click **Data Services > Data Files**.
3. Upload the MicroPython application *main.py* file.
  - a. Click **New Folder**. The **New Folder** dialog displays.
  - b. In the **Folder name** field, enter a descriptive name, such as "MicroPython."
  - c. Click **Create**. The new file is added to the list of files.
  - d. Find the "MicroPython" folder in the folder list.
  - e. Click **Upload Files**. The **Upload Files** dialog displays.
  - f. Browse for the *main.py* file. Check with your system administrator for the location of the application file.
  - g. Click **OK**.
4. Upload the MicroPython library *uftp.py* file.
  - a. Find the "MicroPython" folder in the folder list.
  - b. Click **Upload Files**. The **Upload Files** dialog displays.
  - c. Browse for the *uftp.py* file. The library *uftp.py* file is found on the GitHub repository: <https://github.com/digidotcom/xbec-micropython>
  - d. Click **OK**.

### Step 2: Create an XML file with the tasks that you want to perform

This XML file will contain a list of commands for the operation that you will schedule in [Step 3](#).

---

**Note** The RCI commands to *set\_settings* in the task may fail to execute because of disconnects after changing the value for **MO**.

---

1. Open the editor of your choice.
2. Create a new file named "updatemicropython.xml."
3. Copy the XML below and paste it into the new file.
4. Save the file.

---

```
<task>
  <description>Update MicroPython</description>
  <command>
    <name>SM/UDP Request Connect</name>
    <event>
      <on_error>
```

---

---

```

        <end_task/>
    </on_error>
</event>
<sci>
    <send_message reply="none" >
        <sm_udp>
            <request_connect/>
        </sm_udp>
    </send_message>
</sci>
</command>
<command>
    <name>RCI Command</name>
    <event>
        <on_error>
            <continue/>
        </on_error>
    </event>
    <sci>
        <send_message cache="false" allowOffline="true" >
            <!-- Disable Python Auto-start and enable TCP connection for
remainder of commands-->
            <rci_request>
                <set_setting>
                    <micropython>
                        <PS>0</PS>
                    </micropython>
                    <remote_manager>
                        <MO>7</MO>
                    </remote_manager>
                </set_setting>
            </rci_request>
        </send_message>
    </sci>
</command>
<command>
    <!-- Reboot to stop MicroPython -->
    <name>Reboot</name>
    <event>
        <on_error>
            <continue/>
        </on_error>
    </event>
    <sci>
        <reboot allowOffline="true" waitForReconnect="true"/>
    </sci>
</command>
<!-- Update MicroPython application-->
<command>
    <name>Upload Files</name>
    <event>
        <on_error>
            <continue/>
        </on_error>
    </event>
    <sci>
        <file_system allowOffline="true" >
            <commands>
                <put_file path="/flash/main.py">
                    <file>~/MicroPython/main.py</file>

```

---

---

```

        </put_file>
    </commands>
</file_system>
</sci>
</command>
<command>
    <name>Upload Files</name>
    <event>
        <on_error>
            <continue/>
        </on_error>
    </event>
    <sci>
        <file_system allowOffline="true" >
            <commands>
                <put_file path="/flash/lib/uftp.py">
                    <file>~/MicroPython/uftp.py</file>
                </put_file>
            </commands>
        </file_system>
    </sci>
</command>
<command>
    <name>RCI Command</name>
    <event>
        <on_error>
            <continue/>
        </on_error>
    </event>
    <sci>
        <send_message cache="false" allowOffline="true">
            <!-- Enable Python Auto-start -->
            <rci_request>
                <set_setting>
                    <micropython>
                        <PS>1</PS>
                    </micropython>
                    <remote_manager>
                        <MO>6</MO>
                    </remote_manager>
                </set_setting>
            </rci_request>
        </send_message>
    </sci>
</command>
    <!-- Reboot to start the program -->
<command>
    <name>Reboot</name>
    <event>
        <on_error>
            <end_task/>
        </on_error>
    </event>
    <sci>
        <reboot allowOffline="true" waitForReconnect="false"/>
    </sci>
</command>
</task>

```

---

### Step 3: Upload the XML to Remote Manager

In this step you will upload the file you just created (*updatemicropython.xml*) to Remote Manager.

1. [Log into Remote Manager](#).
2. Click **Data Services > Data Files**.
3. Upload the XML file you just created: *updatemicropython.xml*
  - a. Find the "~/my\_tasks" folder in the folder list.
  - b. Click **Upload Files**. The **Upload Files** dialog displays.
  - c. Browse for the *updatemicropython.xml* file.
  - d. Click **OK**.

### Step 4: Schedule an operation to upload the files

1. [Log into Remote Manager](#).
2. Click **Documentation > API Explorer**.
3. Click **SCI Targets**. The **Select devices to be used in examples** dialog appears.
  - a. From the **Add Targets** list box, search for the IMEI (device ID) of the device that you want to update.
  - b. Click **Add**. The device is added to the device list.
  - c. Click **OK**.
4. Click the **Examples** drop-down list button.
5. Click **Scheduled Operation > Create immediate running schedule**.
6. Update the XML to refer to the *updatemicropython.xml* file you created previously.

---

```
<!-- Runs immediately -->
<Schedule on="IMMEDIATE">
  <targets>
    <device id="00010000-00000000-03588320-70372440"/>
  </targets>

  <task path="~/my_tasks/updatemicropython.xml"/>
</Schedule>
```

---

7. Click **Send** to schedule the task.
8. Click **Device Management > Operations** to view information about the operation. See [Operations](#) in the *Digi Remote Manager® User Guide* for more information about this page.

## Restore persistent connection to a remote XBee

The default connectivity to Remote Manager in the most recent firmware polls once a day using SM/UDP, which means that your XBee will always appear in a disconnected state and will use significantly less data.

If needed, you can restore the default connectivity to use the former behavior, where the device is continually connected using TCP. To do this, you will need to set bit 0 of the **MO** setting. The suggested value is **7** to connect securely over TLS, or you can use **1** for no security, which is the legacy value.

You can make the change using one of the following methods:



- **Local access:** If you have local access to the device you can use XCTU to change the **MO** setting back to the former default value.
- **Remote access:** If you only have remote access to your XBee you can change the device to maintain a persistent connection to Remote Manager. To do this you can set up a scheduled operation in Remote Manager for your device, as shown below.

---

**Note** You must upgrade your device to the latest firmware for this feature to be available. See [Update the firmware from Remote Manager](#) or [Update the firmware using web services in Remote Manager](#).

---

To set up a scheduled operation to maintain a persistent connection:

1. Make sure that you have enabled SM/UDP. See [Enable SM/UDP](#).
2. [Log into Remote Manager](#).
3. Click **Device Management > Schedules**.
4. Click **New Schedule**. The **New Schedule** page displays.

---

**Note** The **Steps to schedule a task** wizard may display. Click the **x** in the upper left corner to close the wizard. See [Schedule walk-through feature](#) in the *Digi Remote Manager® User Guide* for more information.

---

5. In the **Description** field, enter a name for the schedule, such as "Restore Persistent."
6. Add the following tasks:
  - a. Click **SM/UDP > SM/UPD Request Connect**. A task is added to the dialog.
  - b. Click **Device > RCI Command**. A task is added to the dialog.

Change the RCI command to the following:

---

```
<rci_request>
  <set_setting/>
    <remote_manager>
  <MO>7</MO>
  </remote_manager>
</set_setting>
</rci_request>
```

---

7. Click **Schedule** in the lower right corner of the dialog to schedule the tasks to run. The schedule screen displays.

---

**Note** You can also click **Save as** to save this schedule for future use. The XML for your task is saved in the `~\my_tasks` directory on **Data Services > Data Files** in Remote Manager.

---

8. Select the device(s) on which you want to run this schedule. You can add more than one device.
9. Click **Run Now**. Within the next 24 hours, which is the default polling period for querying Remote Manager, your device will connect and will remain connected, as specified by the change to the **MO** setting.
10. Click **Device Management > Operations** to view information about the operation. See [Operations](#) in the *Digi Remote Manager® User Guide* for more information about this page.

## Manage data in Remote Manager

You can view and manage XBee data in Remote Manager.

## Review device status information from Remote Manager

You can view address, BLE, cellular, firmware, and I/O sampling status information for a XBee device in Remote Manager. The device must be in the Remote Manager inventory device list and be active.

---

**Note** You must upgrade your device to the latest firmware for this feature to be available. See [Update the firmware from Remote Manager](#) or [Update the firmware using web services in Remote Manager](#).

---

**Note** Digi Remote Manager requires TCP and will not work with NB-IoT, unless the carrier supports TCP.

---

1. Set up a persistent connection to connect the device to Remote Manager using one of the following methods:
  - **Remote Manager:** A persistent connection can be set up in Remote Manager. This option should be used when you have many deployed devices and no local access. See [Restore persistent connection to a remote XBee](#).
  - **XCTU:** This option allows immediate access, and should be used when you have local access, such as when using a development kit or in a lab environment.
2. [Log into Remote Manager](#).
3. Click **Device Management > Devices**.
4. Select the device that you want to configure.
5. Click **Properties** in the toolbar. As an alternative, click **Properties > Edit Device Configuration**. The configuration **Home** page appears.
6. Click **Status** in the toolbar to display the status sub-menus.
7. Click on the status group that has information you want to display. The status information is related to AT commands. For information about each AT command in the categories, click on the appropriate link below.
  - [Addressing](#)
  - [Bluetooth](#)
  - [Cellular](#)
  - [Firmware Version/Information](#)
  - [I/O](#)
8. Click **Home** to return to the configuration **Home** page.
9. When all changes are complete, [disconnect the device](#) from Remote Manager.

## Update the firmware from Remote Manager

XBee Smart Modem supports Remote Manager firmware updates.

If you are upgrading the device firmware to a version listed below, your connection will disconnect and by default, your device will query Remote Manager only once a day. If you wish to restore the persistent connection behavior that was the default in prior firmware versions, see [Restore persistent connection to a remote XBee](#).

After you have upgraded to the new firmware version, it is recommended that you keep the polling frequency low to reduce data usage. In order to upgrade firmware in the future, refer to [Example: Update XBee firmware using Remote Manager](#).

Module	Upgrade firmware version
XBee CAT 1 Verizon	1011
XBee 3G	11311
XBee3 LTE-M	11411
XBee3 CAT 1	31011

**Note** Digi Remote Manager requires TCP and will not work with NB-IoT, unless the carrier supports TCP.



**WARNING!** The firmware version 1140F reorganizes the product's flash memory and upgrades the product to version 11410. You cannot downgrade to a version earlier than 11410 after installing 1140F/11410.

To perform a firmware update:

1. Download the updated firmware file for your device from Digi's support site.
  - a. Go to the [Digi XBee3 Cellular LTE-M support page](#).
  - b. Scroll down to the **Firmware Updates** section.
  - c. Locate and click **Digi XBee3 Cellular LTE-M/NB-IoT Gating Firmware** to download the zip file.
  - d. Unzip the file. The file contains either a .ebin or a .gbl file.
2. Set up a persistent connection to connect the device to Remote Manager using one of the following methods:
  - **Remote Manager:** A persistent connection can be set up in Remote Manager. This option should be used when you have many deployed devices and no local access. See [Restore persistent connection to a remote XBee](#).
  - **XCTU:** This option allows immediate access, and should be used when you have local access, such as when using a development kit or in a lab environment.
3. [Log into Remote Manager](#).
4. In your Remote Manager account, click **Device Management > Devices**.
5. Select the first device you want to update.
6. To select multiple devices (must be of the same type), press the Control key and select additional devices.
7. Click **More** in the Devices toolbar and select **Update Firmware** from the Update category of the More menu. The **Update Firmware** dialog appears.
8. Click **Browse** to select the downloaded .ebin or .gbl file that you unzipped earlier.
9. Click **Update Firmware**. The updated devices automatically reboot when the updates are complete.
10. When all changes are complete, [disconnect the device](#) from Remote Manager.

## Update the firmware using web services in Remote Manager

Remote Manager supports both synchronous and asynchronous firmware update using web services. The following examples show how to perform an asynchronous firmware update. See the Remote Manager [documentation](#) for more details on firmware updates.



**WARNING!** The firmware version 1140F reorganizes the product's flash memory and upgrades the product to version 11410. You cannot downgrade to a version earlier than 11410 after installing 1140F/11410.

**Note** Digi Remote Manager requires TCP and will not work with NB-IoT, unless the carrier supports TCP.

1. Download the updated firmware file for your device from Digi's support site.
  - a. Go to the [Digi XBee3 Cellular LTE-M support page](#).
  - b. Scroll down to the **Firmware Updates** section.
  - c. Locate and click **Digi XBee3 Cellular LTE-M/NB-IoT Gating Firmware** to download the zip file.
  - d. Unzip the file. The file contains either a .ebin or a .gbl file.
2. Unzip the file and locate the .ebin file inside the unzipped directory.
3. Send an HTTP SCI request to Remote Manager with the contents of the downloaded .ebin or .gbl file converted to base64 data; see the following examples:

Examples for .ebin:

- [Example: update the XBee .ebin firmware synchronously with Python 3.0](#)
- [Example: use the device's .ebin firmware image to update the XBee firmware synchronously](#)

Examples for .gbl:

- [Example: update the XBee .gbl firmware synchronously with Python 3.0](#)
- [Example: use the device's .gbl firmware image to update the XBee firmware synchronously](#)

### **Example: update the XBee .ebin firmware synchronously with Python 3.0**

```
import base64
import requests

# Location of firmware image
firmware_path = 'XBXC.ebin'

# Remote Manager device ID of the device being updated
device_id = '00010000-00000000-03526130-70153378'

# Remote Manager username and password
username = "my_Remote_manager_username"
password = "my_remote_manager_password"

url = 'https://remotemanager.digi.com/ws/sci'

# Get firmware image
```

---

```

fw_file = open(firmware_path, 'rb')
fw_data = fw_file.read()
fw_data = base64.encodebytes(fw_data).decode('utf-8')

# Form update_firmware request
data = """
<sci_request version="1.0">
  <update_firmware filename="firmware.ebin">
    <targets>
      <device id="{}/>
    </targets>
    <data>{}</data>
  </update_firmware>
</sci_request>
""".format(device_id, fw_data)

# Post request
r = requests.post(url, auth=(username, password), data=data)
if (r.status_code != 200) or ("error" in r.content.decode('utf-8')):
    print("firmware update failed")
else:
    print("firmware update success")

```

---

### **Example: use the device's .ebin firmware image to update the XBee firmware synchronously**

To update the XBee firmware synchronously with Python 3.0, but using the device firmware image already uploaded to Remote Manager, upload the device's \*.ebin firmware to Remote Manager:

1. Download the updated firmware file for your device from [Digi's support site](#). This is a zip file containing .ebin and .mxi files for import.
2. Unzip the file and locate the .ebin inside the unzipped directory.
3. Log in to Remote Manager.
4. Click the **Data Services** tab.
5. Click **Data Files**.
6. Click **Upload Files**; browse and select the \*.ebin firmware file to upload it.
7. Send an HTTP SCI request to Remote manager with the path of the .ebin file; see the example below.

---

```

import base64
import requests

# Location of firmware image on Remote Manager
firmware_path = '~/XBXC.ebin'

# Remote Manager device ID of the device being updated
device_id = '00010000-00000000-03526130-70153378'

# Remote Manager username and password
username = "my_remote_manager_username"
password = "my_remote_manager_password"

url = 'https://remotemanager.digi.com/ws/sci'

# Form update_firmware request

```

---

---

```

data = """
<sci_request version="1.0">
  <update_firmware filename="firmware.ebin">
    <targets>
      <device id="{}/>
    </targets>
    <file>{}/</file>
  </update_firmware>
</sci_request>
""".format(device_id, firmware_path)

# Post request
r = requests.post(url, auth=(username, password), data=data)
if (r.status_code != 200) or ("error" in r.content.decode('utf-8')):
    print("firmware update failed")
else:
    print("firmware update success")

```

---

### **Example: update the XBee .gbl firmware synchronously with Python 3.0**

---

```

import base64
import requests

# Location of firmware image
firmware_path = 'XBXC.gbl'

# Remote Manager device ID of the device being updated
device_id = '00010000-00000000-03526130-70153378'

# Remote Manager username and password
username = "my_Remote_manager_username"
password = "my_remote_manager_password"

url = 'https://remotemanager.digi.com/ws/sci'

# Get firmware image
fw_file = open(firmware_path, 'rb')
fw_data = fw_file.read()
fw_data = base64.encodebytes(fw_data).decode('utf-8')

# Form update_firmware request
data = """
<sci_request version="1.0">
  <update_firmware filename="firmware.gbl">
    <targets>
      <device id="{}/>
    </targets>
    <data>{}/</data>
  </update_firmware>
</sci_request>
""".format(device_id, fw_data)

# Post request
r = requests.post(url, auth=(username, password), data=data)
if (r.status_code != 200) or ("error" in r.content.decode('utf-8')):
    print("firmware update failed")
else:
    print("firmware update success")

```

---

### **Example: use the device's .gbl firmware image to update the XBee firmware synchronously**

To update the XBee firmware synchronously with Python 3.0, but using the device firmware image already uploaded to Remote Manager, upload the device's \*.gbl firmware to Remote Manager:

1. Download the updated firmware file for your device from [Digi's support site](#). This is a zip file containing .gbl and .mxi files for import.
2. Unzip the file and locate the .gbl file inside the unzipped directory.
3. Log in to Remote Manager.
4. Click the **Data Services** tab.
5. Click **Data Files**.
6. Click **Upload Files**; browse and select the \*.gbl firmware file to upload it.
7. Send an HTTP SCI request to Remote manager with the path of the .gbl file; see the example below.

---

```
import base64
import requests

# Location of firmware image on Remote Manager
firmware_path = '~/XBXC.gbl'

# Remote Manager device ID of the device being updated
device_id = '00010000-00000000-03526130-70153378'

# Remote Manager username and password
username = "my_remote_manager_username"
password = "my_remote_manager_password"

url = 'https://remotemanager.digi.com/ws/sci'

# Form update_firmware request
data = """
<sci_request version="1.0">
  <update_firmware filename="firmware.gbl">
    <targets>
      <device id="{}/>
    </targets>
    <file>{}</file>
  </update_firmware>
</sci_request>
""".format(device_id, firmware_path)

# Post request
r = requests.post(url, auth=(username, password), data=data)
if (r.status_code != 200) or ("error" in r.content.decode('utf-8')):
    print("firmware update failed")
else:
    print("firmware update success")
```

---

## **Manage secure files in Remote Manager**

You can interact with files on the XBee device from Remote Manager, using either the [SCI \(Server command interface\)](#) or in the **File Management** view.

You can securely upload files by appending a hash sign (#) to the end of the file name. After the upload, the hash sign (#) is not retained as part of the file name. For example, you could upload a file named *my-cert.crt* appended with a hash sign (#): *my-cert.crt#*. After the upload is complete, the file is named *my-cert.crt*.

---

**Note** Uploading secure files in Remote Manager has the same result as doing an [ATFS XPUT](#) locally. See [Secure files](#) for more information.

---

### **SCI (Server command interface)**

You can use the [SCI \(Server command interface\)](#) `file_system` command to securely upload a file. For more information, see the [file\\_system](#) section in the [Digi Remote Manager Programming Guide](#).

### **File Management view**

You can upload and manage files in the Remote Manager **File Management** view.

1. Prepare the file that you want to upload.
  - a. Find the file on your hard drive.
  - b. Rename the file and append a hash sign (#) to the end of the file name.
2. Set up a persistent connection to connect the device to Remote Manager using one of the following methods:
  - **Remote Manager:** A persistent connection can be set up in Remote Manager. This option should be used when you have many deployed devices and no local access. See [Restore persistent connection to a remote XBee](#).
  - **XCTU:** This option allows immediate access, and should be used when you have local access, such as when using a development kit or in a lab environment.
3. [Log into Remote Manager](#).
4. Click **Device Management > Devices**.
5. Select the device that you want to configure.
6. Click **Properties** in the toolbar. As an alternative, double-click on the device name. The **Properties** page appears.
7. Click **File Management**. The **File Management** view appears.
8. Click the upload icon. The **Upload File** dialog appears.
  - a. Click **Browse** to browse for the file you want to upload. The selected file displays in the **File** field. Make sure that the file name is appended by a hash sign (#).
  - b. Click **OK**. The uploaded file displays in the **File Management** view. Note that the file name is no longer appended by a hash sign (#).
9. When all changes are complete, [disconnect the device](#) from Remote Manager.

## **Remote Manager reference**

### **Enable SM/UDP**

You can use the SM/UDP feature to leverage the very small data footprint of Remote Manager SM protocol over UDP.



1. [Log into Remote Manager](#).
2. Click **Device Management > Devices**.
3. Select the device that you want to configure.
4. Click **More > SM/UDP > Configure**. The **SM/UDP** dialog appears.
5. Verify that the **Battery Operated Mode** is not selected.  
This mode is not supported with Remote Manager and if enabled, the connectivity between XBee and Remote Manager may not work as expected.
6. Select **SM/UDP Service Enabled** to enable SM/UDP.
7. Click **Save**.

---

**Note** Do not enable battery-operated mode. This mode is not supported with Remote Manager and if enabled, the connectivity between XBee and Remote Manager may not work as expected.

---

## Disconnect

The TCP connection remains open and periodic polling occurs until you manually disconnect the TCP connection. After you have disconnected the TCP connection, Remote Manager is no longer updated.

You can disconnect the TCP connection using either of the following methods:

- From the **Devices** page in Remote Manager: See [Disconnect a device](#) in the *Digi Remote Manager® User Guide*.
- Using web services in Remote Manager: See [Request connect SM/UDP support](#) in the *Digi Remote Manager® Programming Guide*.

## Configure XBee settings within Remote Manager

You can configure the device settings to use features with Remote Manager. For more information, see [Example: Read settings and state using Remote Manager](#).

### **Configure device settings in Remote Manager**

You can configure each XBee device from Remote Manager. The devices must be in the Remote Manager inventory device list and be active.

---

**Note** Digi Remote Manager requires TCP and will not work with NB-IoT, unless the carrier supports TCP.

---

1. Set up a persistent connection to connect the device to Remote Manager using one of the following methods:
  - **Remote Manager:** A persistent connection can be set up in Remote Manager. This option should be used when you have many deployed devices and no local access. See [Restore persistent connection to a remote XBee](#).
  - **XCTU:** This option allows immediate access, and should be used when you have local access, such as when using a development kit or in a lab environment.
2. [Log into Remote Manager](#).
3. Click **Device Management > Devices**.
4. Select the device that you want to configure.

5. Click **Properties** in the toolbar. As an alternative, click **Properties > Edit Device Configuration**. The configuration **Home** page appears.
6. Click **Config** in the toolbar to display the settings sub-menus.
7. Click on the settings category that you want to configure. The settings in that category appear.
8. Make the desired configuration changes. See [AT commands](#) for information about each setting in the categories.
9. As you finish configuring in each setting category, click **Apply** to save the changes. If the changes are valid, Remote Manager writes them to non-volatile memory and applies them.
10. When all changes are complete, [disconnect the device](#) from Remote Manager.

### **Configure Remote Manager keepalive interval**

---

**Note** Digi Remote Manager requires TCP and will not work with NB-IoT, unless the carrier supports TCP.

---

Managing the data usage and the keepalive interval is important if you have the [MO \(Remote Manager Options\)](#) command bit 0 set to 1 or if you have enabled the [Request connect feature](#) in Remote Manager.

Digi Remote Manager is enabled on the XBee by default and has a 60 second keepalive interval, which can result in excessive cellular data usage, depending on your plan. The [K1](#) and [K2](#) commands can be used to tune the keepalive interval. Your carrier will disconnect an inactive socket automatically if there is no activity, so you need to tune this value based on your carrier's disconnect timeout.

You can further reduce your data usage by periodically duty cycling your Remote Manager connection, either from MicroPython or your host processor. For example, you could enable the Remote Manager connection for 2 hours a day and then disable the connection for 22 hours. Your host processor or MicroPython program would need to keep track of the time to ensure the time interval.

### **Configure SMS messaging in Remote Manager**

You can configure a XBee device to use SMS functionality in Remote Manager. This feature uses a "request connect" operation and asks a device to make a full TCP connection to Remote Manager. For a device with SMS capability this can be significantly lower on latency and data cap consumption, as it does not involve polling.

Each device must be individually configured in Remote Manager to use this feature.

---

**Note** The SMS provision feature cannot be used. This feature is found by selecting a device and then choosing **More > SMS > Provision**. Attempts to enable this feature are ignored.

---

1. Set up a persistent connection to connect the device to Remote Manager using one of the following methods:
  - **Remote Manager:** A persistent connection can be set up in Remote Manager. This option should be used when you have many deployed devices and no local access. See [Restore persistent connection to a remote XBee](#).
  - **XCTU:** This option allows immediate access, and should be used when you have local access, such as when using a development kit or in a lab environment.
2. [Log in to Remote Manager](#).
3. Select the **Device Management** tab.
4. Select the device that you want to configure.

5. In the toolbar, select **More > SMS > Configure**. The **SMS Configuration** dialog appears.
6. Select the **SIM 1** option. This should be selected by default.
7. In the **Phone Number** field, enter the device's SIM card phone number. You can use the [PH \(Phone Number\)](#) command to discover the device's phone number.
8. Expand the **Advanced Options** section.
9. From the **Server Number for SIM 1** list box, select the appropriate option:
  - If the Remote Manager phone number is a domestic number, select a short code. The default is **32075-idgp**.
  - If the Remote Manager phone number is an international number, select a long code.

---

**Note** The options in the **Server Number for SIM 1** list box are determined within Remote Manager, and are used to ensure an SMS connection between the device and Remote Manager. The option selected from the list box must match the Remote Manager phone number and service ID set for the device. The XBee examines received SMS messages and if the phone number matches and content contains the correct service ID it will be processed internally rather than being delivered as user data. By default, the device is configured with "32075" as the Remote Manager phone number and "idgp" as the Remote Manager service ID. If you need an alternate short (domestic) code or a long (international) code, you can re-configure the device using the [DP \(Remote Manager Phone Number\)](#) and [RI \(Remote Manager Service ID\)](#) commands.

---

10. Click **Save**.
11. When all changes are complete, [disconnect the device](#) from Remote Manager.

## Technical specifications

---

Interface and hardware specifications .....	93
Cellular RF characteristics .....	93
Bluetooth RF characteristics .....	93
Cellular networking specifications .....	93
Power requirements .....	94
Power consumption .....	95
Electrical specifications .....	96
Regulatory approvals .....	97

## Interface and hardware specifications

The following table provides the interface and hardware specifications for the device.

Specification	Value
Dimensions	24.38 mm x 32.94 mm (0.960 x 1.297 in)
Weight	5 g (0.18 oz)
Operating temperature	-40 to +85 °C
Antenna connector	Cellular: U.FL Bluetooth: U.FL
Digital I/O	13 I/O lines, I <sup>2</sup> C
ADC	4 10-bit analog inputs
Analog input voltage range	0 - 2.5 V
Cellular chipset	u-blox SARA-R410M-028
Form factor	Digi XBee 20-pin through-hole
SIM size	4FF Nano

## Cellular RF characteristics

The following table provides the RF characteristics for the device.

Specification	Value
Transmit power	Up to 23 dBm, Power Class 3
Receive sensitivity	-105 dBm

## Bluetooth RF characteristics

The following table provides the Bluetooth RF characteristics for the device.

Specification	Value
Transmit power	Up to 8 dBm
Receive sensitivity, 1 Mb/s data rate	-92 dBm
Receive sensitivity, 2 Mb/s data rate	-88 dBm
Operating frequency band	ISM 2.4 - 2.4835 GHz

## Cellular networking specifications

The following table provides the networking and carrier specifications for the device.

Specification	Value
Carrier and technology	AT&T and Verizon LTE-M T-Mobile NB-IoT in US Vodafone and Deutsche Telekom NB-IoT in Europe Compatible with other LTE-M carriers, see supported bands
Supported bands	LTE FDD bands: <ul style="list-style-type: none"> <li>■ Band 12 (700 Mhz)</li> <li>■ Band 28 (700 MHz)</li> <li>■ Band 13 (700 MHz)</li> <li>■ Band 20 (800 MHz)</li> <li>■ Band 26 (850 MHz)</li> <li>■ Band 18 (850 MHz)</li> <li>■ Band 5 (850 MHz)</li> <li>■ Band 19 (850 MHz)</li> <li>■ Band 8 (900 MHz)</li> <li>■ Band 4 (1700 MHz)</li> <li>■ Band 3 (1800 Mhz)</li> <li>■ Band 2 (1900 MHz)</li> <li>■ Band 25 (1900 MHz)</li> <li>■ Band 1 (2100 MHz)</li> </ul> LTE TDD bands: <ul style="list-style-type: none"> <li>■ Band 39 (1900 MHz)</li> </ul>
Security	Digi Trustfence™
Downlink/uplink speeds	Up to 375 kb/s
Duplex mode	Half-duplex

## Power requirements

The following table provides the power requirements for the device.

Specification	Value
Supply voltage	3.3 to 4.3 V

## Power consumption

Specification	State	Using serial interface, VCC = 3.3 V	Using USB direct mode, VCC = 3.3 V
Peak transmit current	Bluetooth disabled	550 mA	550 mA
	Bluetooth enabled	610 mA	610 mA
Average connected mode current	TX/RX @ 23 dBm	205 mA	220 mA
Active mode current	Idle/connected, listening	20 mA	35 mA
Power save mode current		20 $\mu$ A	Not supported
Deep sleep current		10 $\mu$ A	10 $\mu$ A (USB direct mode must be disabled during sleep)

## Electrical specifications

The following table provides the electrical specifications for the XBee Smart Modem.

Symbol	Parameter	Condition	Min	Typical	Max	Units
VCCMAX	Maximum limits of VCC line		0		4.3	V
VDD_IO	Internal supply voltage for I/O		(VCC - 0.15 V) or 3.3 V, whichever is lower	VCC or 3.3 V, whichever is lower	3.3	V
VI	Other XBee pins		-0.3		VDD_IO + 0.3	V
	Voltage on XBee pin 6 (5 V tolerant)		-0.3	5.25 or VDD_IO+2, whichever is lower <sup>1</sup>		
VIL	Input low voltage				0.3*VDD_IO	V
VIH	Input high voltage		0.7*VDD_IO			V
VOL	Voltage output low	Sinking 3 mA, VCC = 3.3 V			0.2*VDD_IO	V
VOH	Voltage output high	Sourcing 3 mA, VCC = 3.3 V	0.8*VDD_IO			V
I_IN	Input leakage current	High Z state I/O connected to Ground or VDD_IO		0.1	30	nA
RPU	Internal pull-up resistor	Enabled		40		kΩ
RPD	Internal pull-down resistor	Enabled		40		kΩ

<sup>1</sup>Pin 6 is 5 V tolerant even when the XBee Smart Modem is not powered. We recommend only driving this pin with 3.3 V for compatibility with other XBee products.



## Regulatory approvals

The following table provides the regulatory and carrier approvals for the device.

Specification	Value
Model	XB3M1
United States	FCC ID: MCQ-XB3M1 FCC ID: XPY2AGQN4NNN
Innovation, Science and Economic Development Canada (ISED)	IC: 1846A-XB3M1 IC: 8595A-2AGQN4NNN
RoHS	Lead-free and RoHS compliant
AT&T end-device certified	Complete
Verizon end-device certified	Complete
PTCRB	Complete
Bluetooth	Declaration ID: D042514 QDID: 121268

## Hardware

---

Mechanical drawings .....	99
Pin signals .....	99
RSSI PWM .....	101
SIM card .....	101
Associate LED functionality .....	101

## Mechanical drawings

The following figures show the mechanical drawings for the XBee Smart Modem. All dimensions are in inches.

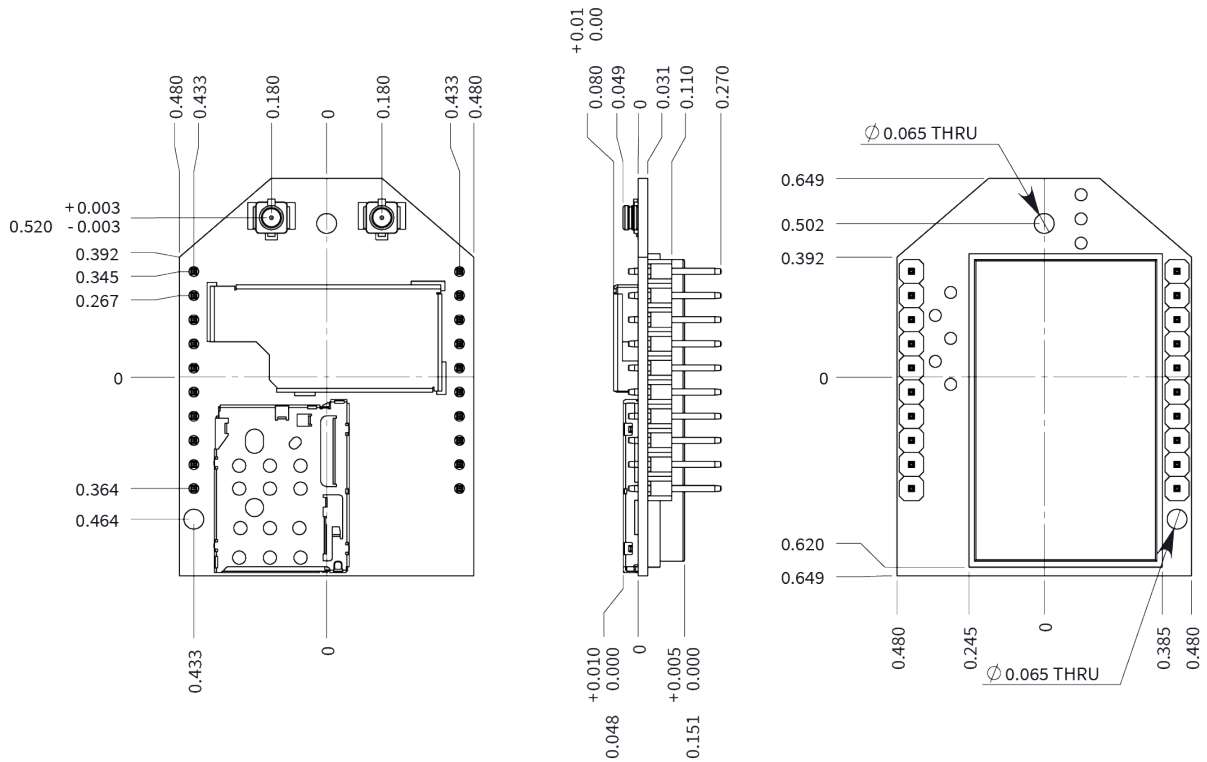

## Pin signals

The pin locations are:

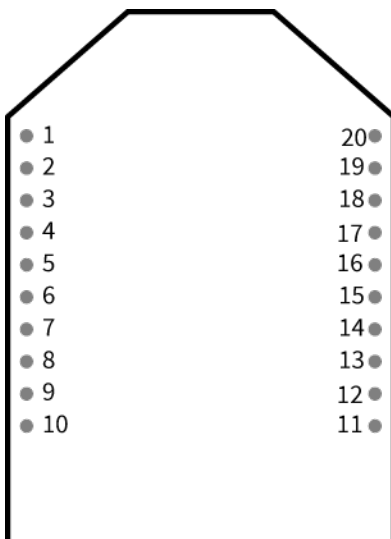

The following table shows the pin assignments for the through-hole device. In the table, low-asserted signals have a horizontal line above signal name.

Pin	Name	Direction	Default	Description
1	V <sub>CC</sub>			Power supply
2	DOUT	Output	Output	UART Data Out
3	DIN / $\overline{\text{CONFIG}}$	Input	Input	UART Data In
4	DIO12 / SPI_MISO	Either	Disabled	Digital I/O 12 or SPI Slave Output line <sup>1</sup>
5	$\overline{\text{RESET}}$	Input		
6	PWM0 / RSSI / DIO10/USB_VBUS	Either	Output	PWM Output 0 / RX Signal Strength Indicator / Digital I/O 10
7	DIO11/USB D+	Either	Disabled	Digital I/O 11 or USB Direct D+ line
8	USB D-			USB Direct D- line
9	$\overline{\text{DTR}}$ / SLEEP_RQ/ DIO8	Either	Disabled	Pin Sleep Control Line or Digital I/O 8
10	GND			Ground
11	DIO4 / SPI_MOSI	Either	Disabled	Digital I/O 4 or SPI Slave Input Line
12	$\overline{\text{CTS}}$ / DIO7	Either	Output	Output Clear-to-Send Flow Control or Digital I/O 7
13	ON / $\overline{\text{SLEEP}}$ /DIO9	Output	Output	Module Status Indicator or Digital I/O 9
14	VREF	-		Feature not supported on this device. Used on other XBee devices for analog voltage reference.
15	Associate / DIO5	Either	Output	Associated Indicator, Digital I/O 5
16	$\overline{\text{RTS}}$ / DIO6	Either	Disabled	Input Request-to-Send Flow Control, Digital I/O 6
17	$\overline{\text{AD3}}$ / DIO3 / SPI_SS	Either	Disabled	Analog Input 3 or Digital I/O 3, SPI low enabled select line
18	AD2 / DIO2 / SPI_CLK	Either	Disabled	Analog Input 2 or Digital I/O 2, SPI Clock line
19	$\overline{\text{AD1}}$ / DIO1 / SPI_ATT $\overline{\text{N}}$	Either	Disabled	Analog Input 1 or Digital I/O 1, SPI Attention line output
20	AD0 / DIO0	Either	Input	Analog Input 0, Digital I/O 0

## Pin connection recommendations

To ensure compatibility with future updates, make USB D+ and D- (pin 7 and pin 8) available in your design.

---

<sup>1</sup>DIO12/SPI\_MISO and DIO4/SPI\_MOSI (pin 4 and pin 11) may optionally be configured as a secondary UART serial port using MicroPython. See the [Digi MicroPython Programming Guide](#) for details.

The recommended minimum pin connections are VCC, GND, DIN, DOUT,  $\overline{\text{RTS}}$ ,  $\overline{\text{DTR}}$  and  $\overline{\text{RESET}}$ . Firmware updates require access to these pins.

## RSSI PWM

The XBee Smart Modem features an RSSI/PWM pin (pin 6) that, if enabled, adjusts the PWM output to indicate the signal strength of the cellular connection. Use [P0 \(DIO10/PWM0 Configuration\)](#) to enable the RSSI pulse width modulation (PWM) output on the pin. If **P0** is set to 1, the RSSI/PWM pin outputs a PWM signal where the frequency is adjusted based on the received signal strength of the cellular connection.

The RSSI/PWM output is enabled continuously unlike other XBee products where the output is enabled for a short period of time after each received transmission. If running on the XBIB development board, DIO10 is connected to the RSSI LEDs, which may be interpreted as follows:

PWM duty cycle	Number of LEDs turned on	Received signal strength (dBm)
79.39% or more	3	-83 dBm or higher
62.42% to 79.39%	2	-93 to -83 dBm
45.45% to 62.42%	1	-103 to -93 dBm
Less than 45.45%	0	Less than -103 dBm, or no cellular network connection

## SIM card

The XBee Smart Modem uses a 4FF (Nano) size SIM card.



**CAUTION!** Never insert or remove SIM card while the power is on!

## Associate LED functionality

The following table describes the Associate LED functionality. For the location of the Associate LED on the XBIB-U development board, see number 6 on the [XBIB-U-DEV reference](#).

LED status	Blink timing	Meaning
On, solid		Not joined to a mobile network.
Double blink	½ second	The last TCP/UDP attempt failed. If the LED has this pattern, you may need to check <a href="#">DI (Remote Manager Indicator)</a> or <a href="#">CI (Protocol/Connection Indication)</a> for the cause of the error.
Standard single blink	1 second	Normal operation.

The normal association LED signal alternates evenly between high and low as shown below:



Where the low signal means LED off and the high signal means LED on.

When **CI** is not **0** or **0xFF**, the Associate LED has a different blink pattern that looks like this:



## Antenna recommendations

---

Antenna placement .....104

## Antenna placement

Antenna location is important for optimal performance. The following suggestions help you achieve optimal antenna performance. See [Regulatory information](#) for details on cellular and Bluetooth antennas that you may use with the XBee Smart Modem.

Keep the antenna(s) as far away from metal objects and other electronics (including the XBee Smart Modem) as possible. Metal objects near the antenna cause parasitic coupling and detuning, preventing the antenna from radiating efficiently. Metal objects between the transmitter and receiver can also block the radiation path or reduce the transmission distance. Some objects that are often overlooked are:

- Metal poles
- Metal studs or beams in structures
- Concrete (reinforced with metal rods)
- Metal enclosures
- Vehicles
- Elevators
- Ventilation ducts
- Batteries
- Tall electrolytic capacitors

Often, small antennas are desirable, but may come at the cost of reduced range and efficiency.

If you implement the Bluetooth interface, ensure that the Bluetooth and cellular antennas are at least 3 inches apart (6 inches recommended) to prevent cellular sensitivity from being degraded.



## Design recommendations

---

Cellular component firmware updates .....	106
Power supply considerations .....	106
Minimum connection diagram .....	106
Heat considerations and testing .....	107
Custom configuration: Create a new factory default .....	107
Clean shutdown .....	108

## Cellular component firmware updates

Even if you do not plan to use the USB interface (Pin 7 and 8), we strongly recommend you provide a way to access the USB pins (Pin 7 and 8) to support direct firmware updates of the Cellular modem. You should keep Pins 7 and 8 routing as a 90 ohm diff pair for USB communications.



**CAUTION!** If you do not provide access to these USB pins, you may be unable to perform cellular component firmware updates.

---

One way to provide access to the USB interface is to connect the USB pins to a header or USB connector on the host design; see [Run the MicroPython GPS demo](#) for more information. At a minimum you should connect pins 7 and 8 to test points so they are easy to wire to a connector if necessary.

If you are using the USB pins for other purposes you must provide a way to disconnect those interfaces during USB operation, such as using zero ohm resistors.

## Power supply considerations

---

**Note** XBee LTE-M parts with an early revision of the microcontroller unit (MCU) may experience an issue recovering from brownouts under rare conditions. See [Brownout issue](#) for details on how to avoid this issue.

---

When considering a power supply, use the following design practices.

1. Power supply ripple should be less than 75 mV peak to peak.
2. The power supply should be capable of providing a minimum of 750 mA at 3.3 V (2.5 W).
3. Place sufficient bulk capacitance on the XBee VCC pin to maintain voltage above the minimum specification during transmissions. [Power consumption](#) lists the peak current during transmitting.
4. Place smaller high frequency ceramic capacitors very close to the XBee Smart Modem VCC pin to decrease high frequency noise.
5. Use a wide power supply trace or power plane to ensure it can handle the peak current requirements with minimal voltage drop. The supply should be inside the supply voltage operating range at startup and should not be allowed to droop lower than 3.2 V during operation.

## Minimum connection diagram

In high EMI noise environments, we recommend adding a 10 nF ceramic capacitor very close to pin 5.

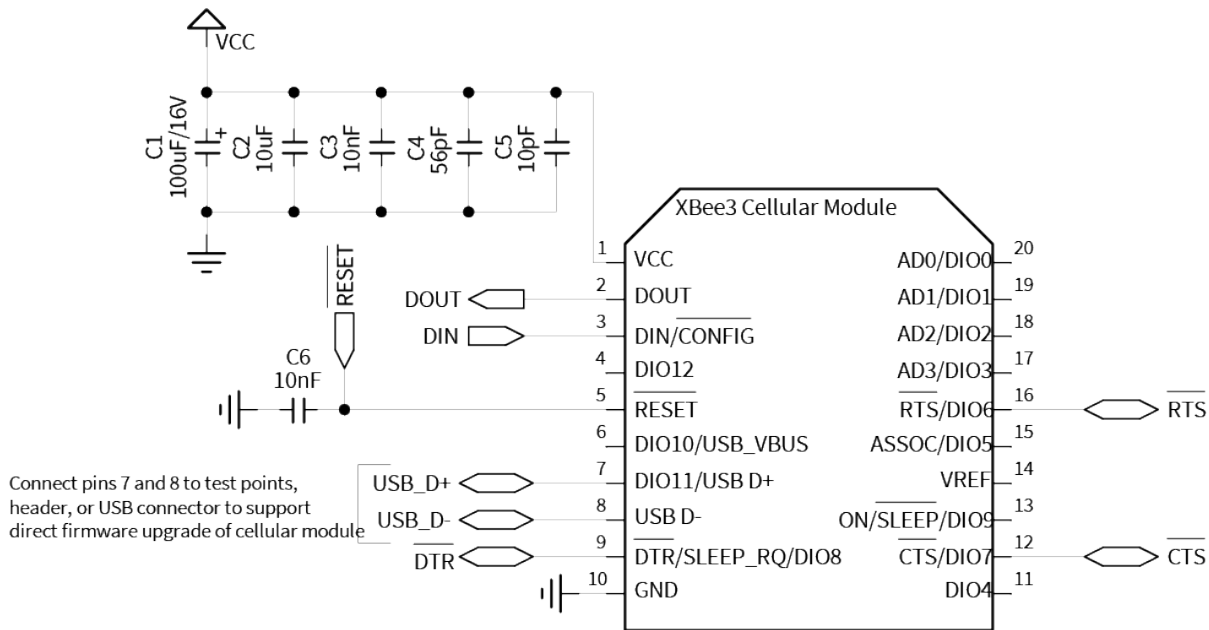

## Heat considerations and testing

The XBee Smart Modem may generate significant heat during sustained operation. In addition to heavy data transfer, other factors that can contribute to heating include ambient temperature, air flow around the device, and proximity to the nearest cellular tower (the XBee Smart Modem must transmit at a higher power level when communicating over long distances). Overheating can cause device malfunction and potential damage.

The XBee Smart Modem must not be operated in ambient temperatures exceeding 85 °C. Additionally, if you expect to operate the product above 70 °C, we recommend that you perform an analysis of your application to characterize the self-heating of the XBee device:

1. Set up the device in the typical operating scenario you plan to use it in.
2. Monitor the device temperature using **TP (Temperature)** until it reaches a steady state.
3. Convert the returned value from hex format to decimal.

If the reading is greater than 5 °C above the ambient temperature, we recommend either de-rating the maximum ambient temperature or implementing heat mitigating measures; for example, reduce transmission frequency and duration, enter sleep mode more frequently, or improve airflow. Addressing heat issues will help to ensure long term device reliability.

## Custom configuration: Create a new factory default

You can create a custom configuration that is used as a new factory default. This feature is useful if you need, for example, to maintain certain settings for manufacturing or want to ensure a feature is always enabled. When you perform a factory reset on the device using the **RE** command, the custom configuration is set on the device rather than the original factory default settings.

For example, by default Bluetooth is disabled on devices. You can create a custom configuration in which Bluetooth is enabled by default. When you use the **RE** command to reset the device to the factory defaults, the Bluetooth configuration is set to the custom configuration (enabled) rather than the original factory default (disabled).

The custom configuration is stored in non-volatile memory. You can continue to create and save custom configurations until the XBee3 memory runs out of space. If there is no space left to save a configuration, XBee returns an error.

You can use the **!C** command to clear or overwrite a custom configuration at any time.

## Set a custom configuration

1. Open XCTU on the device.
2. [Enter Command mode](#).
3. Perform the following process for each configuration that you want to set as a factory default.
  - a. Issue an **AT%F** command. This command enables you to enter a custom configuration.
  - b. Issue the custom configuration command. For example: **ATBT 1**. This command sets the default for Bluetooth to enabled.

## Clear all custom configurations on a device

After you have set configurations using the AT%F command, you can return all configurations to the original factory defaults.

1. Open XCTU on the device.
2. [Enter Command mode](#).
3. Issue **AT!C**.

## Clean shutdown

---



**WARNING!** Improper shutdown of the modem may result in the underlying cellular module becoming irrecoverably unresponsive.

---

Digi strongly recommends performing a clean shutdown procedure on your XBee cellular devices before removing power from the devices. Performing a shutdown allows the module to unregister from the cellular network and safely store operating parameters. Failure to shutdown properly has the potential to result in delays resuming network operation and in some rare instances may result in an unrecoverable module failure.

You can use either of the following methods to perform a clean shutdown.

### Sleep feature

The recommended approach is to use one of the available sleep configurations such as the [Pin Sleep feature \(SM=1\)](#) or sleeping through MicroPython (`xbec.sleep_now()`). When the module has gone to sleep and the [SLEEP pin \(pin 13\)](#) is low, power may safely be removed.

1. Initiate sleep: Assert SLEEP\_RQ
2. Wait for sleep state to be entered: SLEEP pin (pin 13) low.
3. Power off the device.

## Airplane mode

Change the XBee configuration to use Airplane mode (**AM=1**). This puts the XBee into a safe state for shutdown.

1. Set **AM=1**.
2. Apply configuration change.
3. Wait 30 seconds to allow time for shutdown to occur.
4. Power off the device.

## Cellular connection process

---

Connecting .....	111
Data communication with remote servers (TCP/UDP) .....	111
Disconnecting .....	112

## Connecting

In normal operations, the XBee Smart Modem automatically attempts both a cellular network connection and a data network connection on power-up. The sequence of these connections is as follows:

### Cellular network

1. The device powers on.
2. It looks for cellular towers.
3. It chooses a candidate tower with the strongest signal.
4. It negotiates a connection.
5. It completes cellular registration.

### Data network connection

1. The network enables the evolved packet system (EPS) bearer with an access point name (APN). See [AN \(Access Point Name\)](#) if you have APN issues.
2. The device negotiates a data connection with the access point.
3. The device receives its IP configuration and address.
4. The [AI \(Association Indication\)](#) command now returns a **0** and the sockets become available.

## Data communication with remote servers (TCP/UDP)

Once the data network connection is established, communication with remote servers can be initiated in several ways.

---

**Note** For NB-IoT, TCP support is dependent on the network. Contact your network provider for details.

---

- Transparent mode data sent to the serial port (see [TD \(Text Delimiter\)](#) and [RO \(Packetization Timeout\)](#) for timing).
- API mode: [Transmit \(TX\) Request: IPv4 - 0x20](#) received over the serial connection.
- Digi Remote Manager connectivity begins.

Data communication begins when:

1. A socket opens to the remote server.
2. Data is sent.

Data connectivity ends when:

1. The server closes the connection.
2. The **TM** timeout expires (see [TM \(IP Client Connection Timeout\)](#)).
3. The cellular network may also close the connection after a timeout set by the network operator.

## Disconnecting

When the XBee Smart Modem is put into Airplane mode or deep sleep is requested:

1. Sockets are closed, cleanly if possible.
2. The cellular connection is shut down.
3. The cellular component is powered off.

---

**Note** We recommend entering Airplane mode before resetting or rebooting the device to allow the cellular module to detach from the network.

---



## Modes

---

Select an operating mode .....	114
Transparent operating mode .....	115
API operating mode .....	115
Command mode .....	115
MicroPython mode .....	117
USB direct mode .....	118
Bypass operating mode (DEPRECATED) .....	118

## Select an operating mode

The XBee Smart Modem interfaces to a host device such as a microcontroller or computer through a logic-level asynchronous serial port. It uses a [UART](#) for serial communication with those devices.

The XBee Smart Modem supports three operating modes: Transparent operating mode, API operating mode, and Bypass operating mode. The default mode is Transparent operating mode. Use the [AP \(API Enable\)](#) command to select a different operating mode.

The following flowchart illustrates how the modes relate to each other.

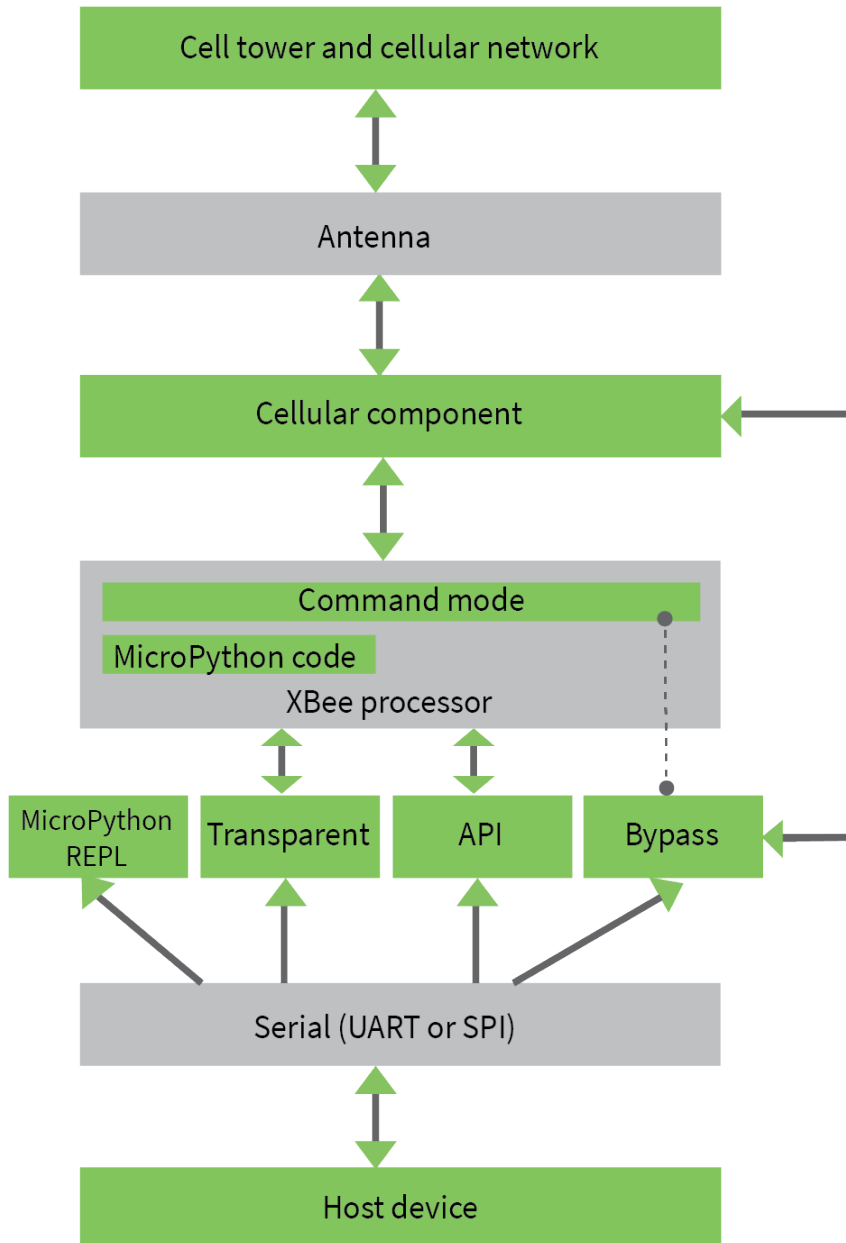

## Transparent operating mode

Devices operate in this mode by default. The device acts as a serial line replacement when it is in Transparent operating mode. The device queues all serial data it receives through the DIN pin for RF transmission. When a device receives RF data, it sends the data out through the DOUT pin. You can set the configuration parameters using Command mode.

The [IP \(IP Protocol\)](#) command setting controls how Transparent operating mode works for the XBee Smart Modem.

---

**Note** Transparent operation is not available when using SPI.

---

## API operating mode

API operating mode is an alternative to Transparent operating mode. API mode is a frame-based protocol that allows you to direct data on a packet basis. The device communicates UART or SPI data in packets, also known as API frames. This mode allows for structured communications with computers and microcontrollers.

The advantages of API operating mode include:

- It is easier to send information to multiple destinations
- The host receives the source address for each received data frame
- You can change parameters without entering Command mode

## Command mode

Command mode is a state in which the firmware interprets incoming characters as commands. It allows you to modify the device's configuration using parameters you can set using AT commands. When you want to read or set any parameter of the XBee Smart Modem using this mode, you have to send an AT command. Every AT command starts with the letters **AT** followed by the two characters that identify the command and then by some optional configuration values.

The operating modes of the XBee Smart Modem are controlled by the [AP \(API Enable\)](#) setting, but Command mode is always available as a mode the device can enter while configured for any of the operating modes.

Command mode is available on the UART interface for all operating modes. You cannot use the SPI interface to enter Command mode.

### Enter Command mode

To get a device to switch into Command mode, you must issue the following sequence: **+++** within one second. There must be at least one second preceding and following the **+++** sequence. Both the command character (**CC**) and the silence before and after the sequence (**GT**) are configurable. When the entrance criteria are met the device responds with **OK\r** on UART signifying that it has entered Command mode successfully and is ready to start processing AT commands.

If configured to operate in [Transparent operating mode](#), when entering Command mode the XBee Smart Modem knows to stop sending data and start accepting commands locally.

---

**Note** Do not press **Return** or **Enter** after typing **+++** because it interrupts the guard time silence and prevents you from entering Command mode.

---

When the device is in Command mode, it listens for user input and is able to receive AT commands on the UART. If **CT** time (default is 10 seconds) passes without any user input, the device drops out of

Command mode and returns to the previous operating mode. You can force the device to leave Command mode by sending [CN \(Exit Command mode\)](#).

You can customize the command character, the guard times and the timeout in the device’s configuration settings. For more information, see [CC \(Command Sequence Character\)](#), [CT \(Command Mode Timeout\)](#) and [GT \(Guard Times\)](#).

## Troubleshooting

Failure to enter Command mode is often due to baud rate mismatch. Ensure that the baud rate of the connection matches the baud rate of the device. By default, [BD \(Baud Rate\)](#) = **3** (9600 b/s).

There are two alternative ways to enter Command mode:

- A serial break for six seconds enters Command mode. You can issue the "break" command from a serial console, it is often a button or menu item.
- Asserting DIN (serial break) upon power up or reset enters Command mode. XCTU guides you through a reset and automatically issues the break when needed.

Both of these methods temporarily set the device's baud rate to 9600 and return an **OK** on the UART to indicate that Command mode is active. When Command mode exits, the device returns to normal operation at the baud rate that **BD** is set to.

## Send AT commands

Once the device enters Command mode, use the syntax in the following figure to send AT commands. Every AT command starts with the letters **AT**, which stands for "attention." The AT is followed by two characters that indicate which command is being issued, then by some optional configuration values. To read a parameter value stored in the device’s register, omit the parameter field.

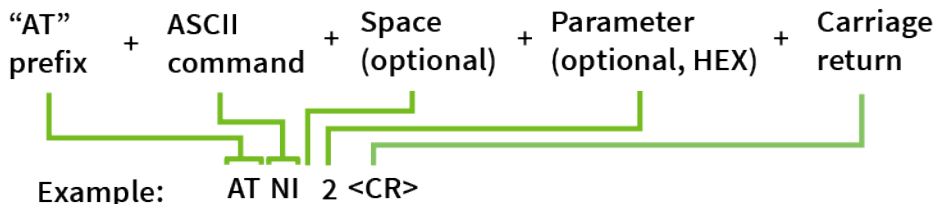

### Multiple AT commands

You can send multiple AT commands at a time when they are separated by a comma in Command mode; for example, **ATNI My XBee,AC<cr>**.

The preceding example changes the **NI (Node Identifier)** to **My XBee** and makes the setting active through [AC \(Apply Changes\)](#).

### Parameter format

Refer to the list of [AT commands](#) for the format of individual AT command parameters. Valid formats for hexadecimal values include with or without a leading **0x** for example **FFFF** or **0xFFFF**.

## Response to AT commands

When using AT commands to set parameters the XBee Smart Modem responds with **OK<cr>** if successful and **ERROR<cr>** if not.

For devices with a file system:

**ATAP1<cr>**

**OK<cr>**

When reading parameters, the device returns the current parameter value instead of an **OK** message.

**ATAP<cr>**

**1<cr>**

## Apply command changes

Any changes you make to the configuration command registers using AT commands do not take effect until you apply the changes. For example, if you send the **BD** command to change the baud rate, the actual baud rate does not change until you apply the changes. To apply changes:

1. Send [AC \(Apply Changes\)](#).
2. Send [WR \(Write\)](#).  
or:
3. [Exit Command mode](#).

## Make command changes permanent

Send a [WR \(Write\)](#) command to save the changes. **WR** writes parameter values to non-volatile memory so that parameter modifications persist through subsequent resets.

Send as [RE \(Restore Defaults\)](#) to wipe settings saved using **WR** back to their factory defaults.

---

**Note** You still have to use **WR** to save the changes enacted with **RE**.

---

## Exit Command mode

1. Send [CN \(Exit Command mode\)](#) followed by a carriage return.  
or:
2. If the device does not receive any valid AT commands within the time specified by [CT \(Command Mode Timeout\)](#), it returns to Transparent or API mode. The default Command mode timeout is 10 seconds.

For an example of programming the device using AT Commands and descriptions of each configurable parameter, see [AT commands](#).

## MicroPython mode

MicroPython mode (**AP = 4**) allows you to communicate with the XBee Smart Modem using the MicroPython programming language. You can use the MicroPython Terminal tool in XCTU to communicate with the MicroPython stack of the XBee Smart Modem through the serial interface.

MicroPython mode connects the primary serial port to the stdin/stdout interface on MicroPython, which is either the REPL or code launched at startup.

When code runs in MicroPython with **AP** set to a value other than **4**, stdout goes to the bit bucket and there is no input to read on stdin.

## USB direct mode

---

**Note** In order to use USB direct mode in Digi XBee development kits, you must use the XBIB-C-TH development board.

---

**Note** You should use this mode if you want to connect using PPP through the cellular modem while using a host operating system, such as embedded Linux.

---

This mode allows you to access the XBee Smart Modem's USB interface directly through XBee pins 7 and 8. VBUS functionality is optionally provided on XBee pin 6 if you wish to enable and disable USB mode based on an external source. While in USB mode the cellular modem is not able to communicate serially with the XBee MCU. All communication with the cellular modem must be performed by the user via the USB port.

### Configure the data pins

Set **P1 (DIO11/PWM1 Configuration)** to **7** to configure pins 7 and 8 for USB direct mode.

If USB Direct is not enabled (**P1** is not set to **7**), then **DO (Device Options)** bit 2 and **P0** being set to **6** have no effect on the USB VBUS state.

### Enable USB direct mode

You can enable USB direct mode in two ways:

1. Enable via software: Set **DO (Device Options)** bit 2. Ensure that **P0 (DIO10/PWM0 Configuration)** is not set to **6** as that would override the **DO** setting.
2. Enable based on the state of VBUS (pin 6): Set **P0** to **6**. Apply a logic high signal to DIO10/PWM0 (pin 6) to enable USB or a logic low signal to disable USB.

---

**Note** Although pin 6 is 5 V tolerant on this device, it operates with the same 3.3 V logic as the other XBee device pins. For compatibility with other XBee devices we recommend driving the line with no more than 3.3 V. Moreover, driving the pin at 5 V will cause input leakage current to increase to 3.3  $\mu$ A typical.

---

You must reset the device to enable or disable USB direct mode.

While in USB direct mode, **AI (Association Indication)** returns 0x2B.

## Bypass operating mode (DEPRECATED)



**WARNING!** Bypass mode is now deprecated and is not recommended for new designs. XBee3 Cellular products support direct USB to access the cellular modem directly. See [USB direct mode](#) for details on how to configure your XBee to use direct USB.

---



**CAUTION!** Bypass operating mode is an alternative to Transparent and API modes for advanced users with special configuration needs. Changes made in this mode might change or disable the device and we do not recommend it for most users.

---



**CAUTION!** The lack of hardware flow control support in the cellular component may impact the reliability of Bypass mode. See [Hardware flow control in Bypass mode](#) for details.

In Bypass mode, the device acts as a serial line replacement to the cellular component. In this mode, the XBee Smart Modem exposes all control of the cellular component's AT port through the UART. If you use this mode, you must setup the cellular modem directly to establish connectivity. The modem does not automatically connect to the network.

**Note** The cellular component can become unresponsive in Bypass mode. See [Unresponsive cellular component in Bypass mode](#) for help in this situation.

When Bypass mode is active, most of the XBee Smart Modem's AT commands do not work. For example, **IM** (IMEI) may never return a value, and **DB** does not update. In this configuration, the firmware does not test communication with the cellular component (which it does by sending AT commands). This is useful in case you have reconfigured the cellular component in a way that makes it incompatible with the firmware. Bypass operating mode exists for users who wish to communicate directly with the cellular component settings and do not intend to use XBee Smart Modem software features such as API mode.

Command mode is available while in Bypass mode; see [Enter Command mode](#) for instructions.

## Enter Bypass operating mode

To configure a device for Bypass operating mode:

1. Set the [AP \(API Enable\)](#) parameter value to **5**.
2. Send [WR \(Write\)](#) to write the changes.
3. Send [FR \(Force Reset\)](#) to reboot the device.
4. After rebooting, enter Command mode and verify that Bypass operating mode is active by querying [AI \(Association Indication\)](#) and confirming that it returns a value of **0x2F**.

It may take a moment for Bypass operating mode to become active.

## Leave Bypass operating mode

To configure a device to leave Bypass operating mode:

1. Set [AP \(API Enable\)](#) to something other than 5.
2. Send [WR \(Write\)](#) to write the changes.
3. Send [FR \(Force Reset\)](#) to reboot the device.
4. After rebooting, enter Command mode and verify that Bypass operating mode is not active by querying [AI \(Association Indication\)](#) and confirming that it returns a value other than **0x2F**.

## Restore cellular settings to default in Bypass operating mode

Send **AT&F1** to reset the cellular component to its factory profile.

## Sleep modes

---

About sleep modes .....	121
Normal mode .....	121
Pin sleep mode .....	121
Cyclic sleep mode .....	121
Cyclic sleep with pin wake up mode .....	121
SPI mode and sleep pin functionality .....	121
The sleep timer .....	122
MicroPython sleep behavior .....	122



## About sleep modes

A number of low-power modes exist to enable devices to operate for extended periods of time on battery power. Use [SM \(Sleep Mode\)](#) to enable these sleep modes.

### Normal mode

Set **SM** to 0 to enter Normal mode.

Normal mode is the default sleep mode. If a device is in this mode, it does not sleep and is always awake.

Devices in Normal mode are typically mains powered.

### Pin sleep mode

Set **SM** to 1 to enter pin sleep mode.

Pin sleep allows the device to sleep and wake according to the state of the SLEEP\_RQ pin (SLEEP\_RQ).

When you assert SLEEP\_RQ (high), the device finishes any transmit or receive operations, closes any active connection, and enters a low-power state.

When you de-assert SLEEP\_RQ (low), the device wakes from pin sleep.

### Cyclic sleep mode

Set **SM** to 4 to enter Cyclic sleep mode.

Cyclic sleep allows the device to sleep for a specific time and wake for a short time to poll.

If you use the **D7** command to enable hardware flow control, the  $\overline{\text{CTS}}$  pin asserts (low) when the device wakes and can receive serial data, and de-asserts (high) when the device sleeps.

### Cyclic sleep with pin wake up mode

Set **SM** to 5 to enter Cyclic sleep with pin wake up mode.

This mode is a slight variation on Cyclic sleep mode (**SM** = 4) that allows you to wake a device prematurely by de-asserting the SLEEP\_RQ pin (SLEEP\_RQ).

In this mode, you can wake the device after the sleep period expires, or if a high-to-low transition occurs on the SLEEP\_RQ pin.

### SPI mode and sleep pin functionality

SLEEP\_RQ/ DIO8 is configured as a peripheral by default and is used for pin sleep to wake the XBee Smart Modem and put it to sleep. This applies regardless of if the serial interface is UART or SPI.

However, if SLEEP\_RQ is not configured as a peripheral and SPI\_SSEL is configured as a peripheral, then pin sleep is controlled by SPI\_SSEL rather than by SLEEP\_RQ. Asserting SPI\_SSEL by driving it low wakes the XBee Smart Modem, or keeps it awake. De-asserting SPI\_SSEL by driving it high puts the device to sleep.

If neither pin is configured as a peripheral, then the device stays awake, being unable to sleep when [SM \(Sleep Mode\)](#) is **1**.

DIO8/SLEEP_RQ configured as peripheral (D8 = 1)?	DIO3/SPI_SSEL configured as peripheral (D3 = 1)?	Pin sleep controlled by...
Yes	Yes	DIO8/SLEEP_RQ
Yes	No	DIO8/SLEEP_RQ
No	Yes	DIO3/SPI_SSEL
No	No	Neither (pin sleep does not work)

Advantage of using SPI\_SSEL to control sleep:

- One less physical pin connection is required to implement pin sleep. This makes DIO8/SLEEP\_RQ available for another purpose.

Disadvantages of using SPI\_SSEL to control sleep:

- The XBee Smart Modem is put to sleep whenever the SPI master negates SPI\_SSEL, even if that was not the intent.
- The XBee Smart Modem begins entering sleep as soon as the control pin is asserted (brought high). Immediately de-asserting the control pin (bringing it low) only has the effect of preventing the microcontroller from entering low-power mode before waking up the device—all other sleep preparations (such as closing sockets) continue as in typical sleep operation. This can take several seconds, and this added time in the case of an unintended sleep request may not be acceptable.

## The sleep timer

The sleep timer starts when the device wakes and resets on re-configuration. When the sleep timer expires the device returns to sleep.

## MicroPython sleep behavior

When the XBee Smart Modem enters Deep Sleep mode, any MicroPython code currently executing is suspended until the device comes out of sleep. When the XBee Smart Modem comes out of sleep mode, MicroPython execution continues where it left off.

Upon entering deep sleep mode, the XBee Smart Modem closes any active UDP connections and turns off the cellular component. As a result, any sockets that were opened in MicroPython prior to sleep report as no longer being connected. This behavior appears the same as a typical socket disconnection event will:

- `socket.send` raises **OSError: ENOTCONN**
- `socket.sendto` raises **OSError: ENOTCONN**
- `socket.recv` returns the empty string, the traditional end-of-file return value
- `socket.recvfrom` returns an empty message, for example:  
(`b''`, (`<address from connect(>`, `<port from connect(>`) )  
The underlying UDP socket resources have been released at this point.

## Power saving features

---

Airplane mode .....	124
Power Saving Mode (PSM) .....	124
PSM behavior .....	124
Deep Sleep mode .....	124

## Airplane mode

While not technically a sleep mode, Airplane mode is another way of saving power. When set, the cellular component of the XBee Smart Modem is fully turned off and no access to the cellular network is performed or possible. Use [AM \(Airplane Mode\)](#) to configure this mode.

## Power Saving Mode (PSM)

To enable PSM, set [DO \(Device Options\)](#) bit 3.

---

**Note** For NB-IoT, TCP and SMS support is dependent on the network. Contact your network provider for details.

---

**Note** The cellular module comes out of the PSM low-power state whenever any network activity occurs, including Remote Manager activity. See [Verify the connection between a device and Remote Manager](#).

---

When PSM is enabled, the cellular component spends most of its time in a low power state. In the low power state the XBee Smart Modem still has an IP address and is registered to the network, which allows for quick resumption of activity, but is not reachable so cannot receive IP or SMS traffic until it wakes up. This low power state is used even when taking advantage of XBee sleep features (such as [Pin Sleep](#) or [Cyclic Sleep](#)), rather than powering the cellular component off entirely to ensure readiness when exiting sleep.

The cellular component wakes to participate in maintaining the network state periodically based on timers negotiated with the cell tower. It is also triggered to wake up when the user performs any activity requiring network connectivity such as mobile-originated traffic like sending an SMS or UDP/TCP traffic. When it wakes up, it spends a short time awake so that it is reachable through the network at that time and then returns to the low power state.

## PSM behavior

Commands exist to influence the PSM behavior when PSM is enabled ([DO bit 3](#) is set).

---

**Note** For NB-IoT, TCP and SMS support is dependent on the network. Contact your network provider for details.

---

They are:

- [PA \(Requested Active Timer\)](#)
- [PU \(Requested Tracking Area Update Timer\)](#)

**PA** and **PU** are the values the XBee Smart Modem requests from the network. The network is free to assign values other than those which have been requested.

See the [LTE-M Deployment Guide](#) from GSMA for a description of what the PSM timers are and what functions they perform on the network.

## Deep Sleep mode

In Deep Sleep mode the cellular component is shut off and the XBee processor is put to sleep.

---

**Note** When the XBee Smart Modem enters deep sleep mode, any MicroPython code currently executing is suspended until the device comes out of sleep.

---

## Serial communication

---

Serial interface .....	127
Serial data .....	127
UART data flow .....	127
Serial buffers .....	128
CTS flow control .....	128
RTS flow control .....	128
Enable UART or SPI ports .....	128
I2C .....	129

## Serial interface

The XBee Smart Modem interfaces to a host device through a serial port. The device's serial port can communicate:

- Through a logic and voltage compatible universal asynchronous receiver/transmitter (UART).
- Through a level translator to any serial device, for example, through an RS-232 or USB interface board.
- Through a serial peripheral interface (SPI) port.

## Serial data

A device sends data to the XBee Smart Modem's UART through pin 3 DIN as an asynchronous serial signal. When the device is not transmitting data, the signals should idle high.

For serial communication to occur, you must configure the UART of both devices (the microcontroller and the XBee Smart Modem) with compatible settings for the baud rate, parity, start bits, stop bits, and data bits.

Each data byte consists of a start bit (low), 8 data bits (least significant bit first) and a stop bit (high). The following diagram illustrates the serial bit pattern of data passing through the device. The diagram shows UART data packet 0x1F (decimal number 31) as transmitted through the device.

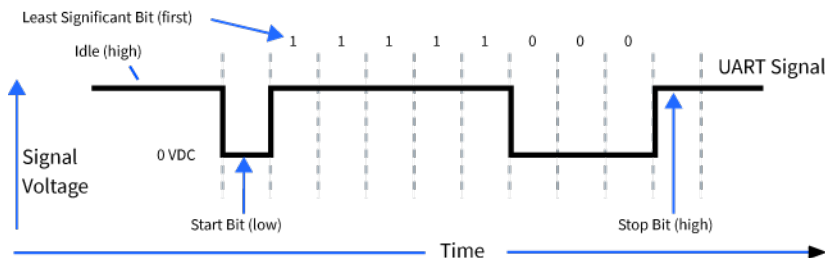

You can configure the UART baud rate, parity, and stop bits settings on the device with the **BD**, **NB**, and **SB** commands respectively. For more information, see [Serial interfacing commands](#).

In the rare case that a device has been configured with the UART disabled, you can recover the device to UART operation by holding DIN low at reset time. DIN forces a default configuration on the UART at 9600 baud and it brings the device up in Command mode on the UART port. You can then send the appropriate commands to the device to configure it for UART operation. If those parameters are written, the device comes up with the UART enabled on the next reset.

## UART data flow

Devices that have a UART interface connect directly to the pins of the XBee Smart Modem as shown in the following figure. The figure shows system data flow in a UART-interfaced environment. Low-asserted signals have a horizontal line over the signal name.

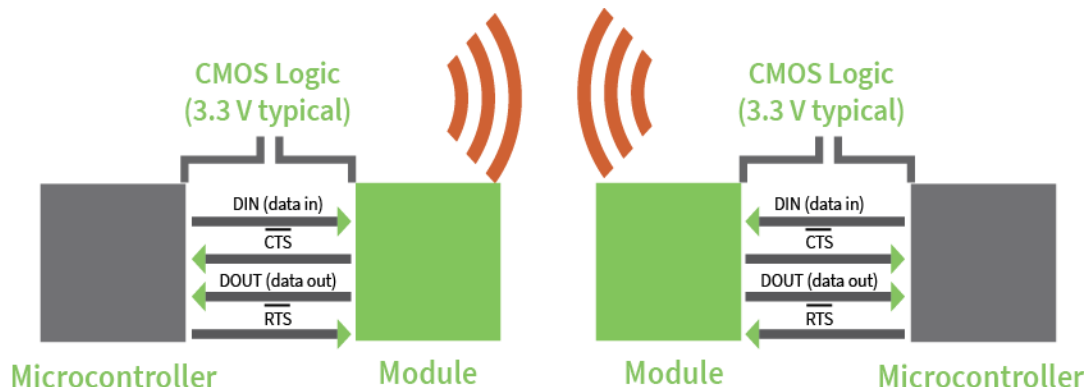

## Serial buffers

The XBee Smart Modem maintains internal buffers to collect serial and RF data that it receives. The serial receive buffer collects incoming serial characters and holds them until the device can process them. The serial transmit buffer collects the data it receives via the RF link until it transmits that data out the serial or SPI port.

## CTS flow control

We strongly encourage you to use flow control with the XBee Smart Modem to prevent buffer overruns.

CTS flow control is enabled by default; you can disable it with [D7 \(DIO7/CTS\)](#). When the serial receive buffer fills with the number of bytes specified by [FT \(Flow Control Threshold\)](#), the device de-asserts CTS (sets it high) to signal the host device to stop sending serial data. The device re-asserts CTS when less than FT-32 bytes are in the UART receive buffer.

---

**Note** Serial flow control is not possible when using the SPI port.

---

## RTS flow control

If you set [D6 \(DIO6/RTS\)](#) to enable RTS flow control, the device does not send data in the serial transmit buffer out the DOUT pin as long as RTS is de-asserted (set high). Do not de-assert RTS for long periods of time or the serial transmit buffer will fill.

## Enable UART or SPI ports

To enable the UART port, configure DIN and DOUT ([P3](#) and [P4](#) parameters) as peripherals. To enable the SPI port, enable SPI\_MISO, SPI\_MOSI, SPI\_SSEL, and SPI\_CLK ([P5](#) through [P9](#)) as peripherals. If you enable both ports then output goes to the UART until the first input on SPI.

When both the UART and SPI ports are enabled on power-up, all serial data goes out the UART. As soon as input occurs on either port, that port is selected as the active port and no input or output is allowed on the other port until the next device reset.

If you change the configuration so that only one port is configured, then that port is the only one enabled or used. If the parameters are written with only one port enabled, then the port that is not enabled is not used even temporarily after the next reset.



If both ports are disabled on reset, the device uses the UART in spite of the wrong configuration so that at least one serial port is operational.

## I<sup>2</sup>C

For I<sup>2</sup>C see the [Class I2C: two-wire serial protocol](#) section in the *MicroPython Programming Guide* for details.

## SPI operation

---

SPI communications .....	131
Full duplex operation .....	132
Low power operation .....	133
Select the SPI port .....	133
Force UART operation .....	134
Data format .....	134

## SPI communications

The XBee Smart Modem supports SPI communications in slave mode. Slave mode receives the clock signal and data from the master and returns data to the master. The following table shows the signals that the SPI port uses on the device.

Signal	Function
SPI_MOSI (Master Out, Slave In)	Inputs serial data from the master
SPI_MISO (Master In, Slave Out)	Outputs serial data to the master
SPI_SCLK (Serial Clock)	Clocks data transfers on MOSI and MISO
SPI_SSEL (Slave Select)	Enables serial communication with the slave
SPI_ATT $\overline{\text{N}}$ (Attention)	Alerts the master that slave has data queued to send. The XBee Smart Modem asserts this pin as soon as data is available to send to the SPI master and it remains asserted until the SPI master has clocked out all available data.

In this mode:

- SPI clock rates up to 4.8 MHz are possible.
- Data is most significant bit (MSB) first; bit 7 is the first bit of a byte sent over the interface.
- Frame Format mode 0 is used. This means CPOL= 0 (idle clock is low) and CPHA = 0 (data is sampled on the clock's leading edge).
- The SPI port only supports API Mode (**AP = 1**).

The following diagram shows the frame format mode 0 for SPI communications.

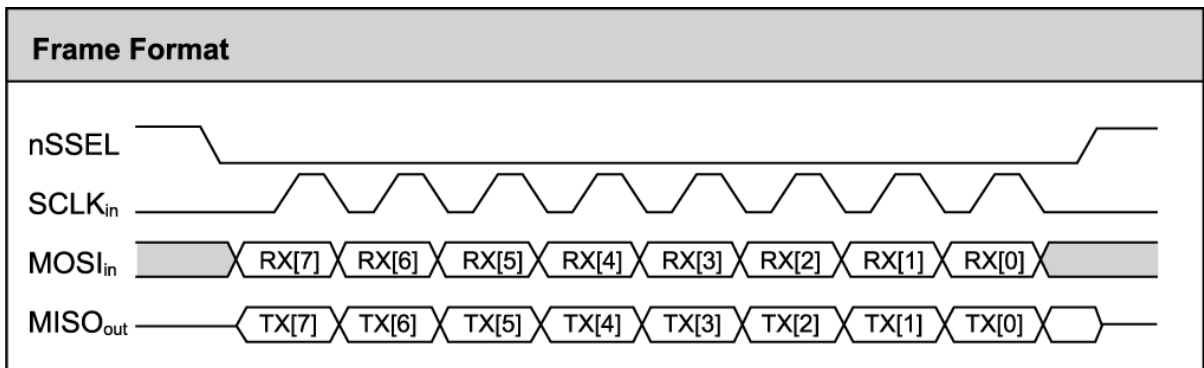

SPI mode is chip to chip communication. We do not supply a SPI communication option on the device development evaluation boards.

## Full duplex operation

The specification for SPI includes the four signals SPI\_MISO, SPI\_MOSI, SPI\_CLK, and SPI\_SSEL. Using these four signals, the SPI master cannot know when the slave needs to send and the SPI slave cannot transmit unless enabled by the master. For this reason, the SPI\_ATTN signal is available in the design. This allows the SPI slave to alert the SPI master that it has data to send. In turn, the SPI master is expected to assert SPI\_SSEL and start SPI\_CLK, unless these signals are already asserted and active respectively. This, in turn, allows the XBee Smart Modem SPI slave to send data to the master.

SPI data is latched by the master and slave using the SPI\_CLK signal. When data is being transferred the MISO and MOSI signals change between each clock. If data is not available then these signals will not change and will be either 0 or 1. This results in receiving either a repetitive 0 or 0xFF. The means of determining whether or not received data is valid is by packetizing the data with API packets, without escaping. Valid data to and from the XBee Smart Modem is delimited by 0x7E, a length, the payload, and finally a checksum byte. Everything else in both directions should be ignored. The bytes received between frames will be either 0xff or 0x00. This allows the SPI master to scan for a 0x7E delimiter between frames.

SPI allows for valid data from the slave to begin before, at the same time, or after valid data begins from the master. When the master is sending data to the slave and the slave has valid data to send in the middle of receiving data from the master, it allows a true full duplex operation where data is valid in both directions for a period of time. During this time, the master and slave must simultaneously transmit valid data at the clock speed so that no invalid bytes appear within an API frame, causing the whole frame to be discarded.

An example follows to more fully illustrate the SPI interface during the time valid data is being sent in both directions. First, the master asserts SPI\_SSEL and starts SPI\_CLK to send a frame to the slave.

Initially, the slave does not have valid data to send the master. However, while it is still receiving data from the master, it has its own data to send. Therefore, it asserts SPI\_ATTN low. Seeing that SPI\_SSEL is already asserted and that SPI\_CLK is active, it immediately begins sending valid data, even while it is receiving valid data from the master. In this example, the master finishes its valid data before the slave does. The master will have two indications of valid data: The SPI\_ATTN line is asserted and the API frame length is not yet expired. For both of these reasons, the master should keep SPI\_SSEL asserted and should keep SPI\_CLK toggling in order to receive the end of the frame from the slave, even though these signals were originally turned on by the master to send data. During the time that the SPI master is sending invalid data to the SPI slave, it is important no 0x7E is included in that invalid data because that would trigger the SPI slave to start receiving another valid frame.

The following figure illustrates the SPI interface while valid data is being sent in both directions.

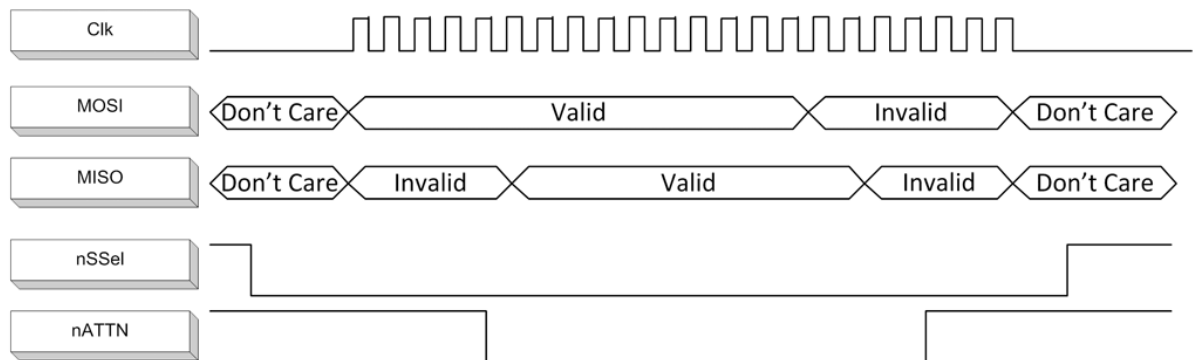

## Low power operation

Sleep modes generally work the same on SPI as they do on UART. However, due to the addition of SPI mode, there is an option of another sleep pin, as described below.

By default, Digi configures DIO8 (SLEEP\_REQUEST) as a peripheral and during pin sleep it wakes the device and puts it to sleep. This applies to both the UART and SPI serial interfaces.

If SLEEP\_REQUEST is not configured as a peripheral and SPI\_SSEL is configured as a peripheral, then pin sleep is controlled by SPI\_SSEL rather than by SLEEP\_REQUEST. Asserting SPI\_SSEL (pin 17) by driving it low either wakes the device or keeps it awake. Negating SPI\_SSEL by driving it high puts the device to sleep.

Using SPI\_SSEL to control sleep and to indicate that the SPI master has selected a particular slave device has the advantage of requiring one less physical pin connection to implement pin sleep on SPI. It has the disadvantage of putting the device to sleep whenever the SPI master negates SPI\_SSEL (meaning time is lost waiting for the device to wake), even if that was not the intent.

If the user has full control of SPI\_SSEL so that it can control pin sleep, whether or not data needs to be transmitted, then sharing the pin may be a good option in order to make the SLEEP\_REQUEST pin available for another purpose.

If the device is one of multiple slaves on the SPI, then the device sleeps while the SPI master talks to the other slave, but this is acceptable in most cases.

If you do not configure either pin as a peripheral, then the device stays awake, being unable to sleep in SM1 mode.

## Select the SPI port

To force SPI mode, hold DOUT/DIO13 pin 2 low while resetting the device until SPI\_ATT $\bar{N}$  asserts. This causes the device to disable the UART and go straight into SPI communication mode. Once configuration is complete, the device queues a modem status frame to the SPI port, which causes the SPI\_ATT $\bar{N}$  line to assert. The host can use this to determine that the SPI port is configured properly. This method forces the configuration to provide full SPI support for the following parameters:

- **D1** (This parameter will only be changed if it is at a default of zero when the method is invoked.)
- **D2**
- **D3**
- **D4**
- **P2**

As long as the host does not issue a **WR** command, these configuration values revert to previous values after a power-on reset. If the host issues a **WR** command while in SPI mode, these same parameters are written to flash. After a reset, parameters that were forced and then written to flash become the mode of operation.

If the UART is disabled and the SPI is enabled in the written configuration, then the device comes up in SPI mode without forcing it by holding DOUT low. If both the UART and the SPI are enabled at the time of reset, then output goes to the UART until the host sends the first input. If that first input comes on the SPI port, then all subsequent output goes to the SPI port and the UART is disabled. If the first input comes on the UART, then all subsequent output goes to the UART and the SPI is disabled.

Once you select a serial port (UART or SPI), all subsequent output goes to that port, even if you apply a new configuration. The only way to switch the selected serial port is to reset the device. On surface-mount devices, forcing DOUT low at the time of reset has no effect. To use SPI mode on the SMT devices, assert the SPI\_SSEL (pin 17) low after reset and before any UART data is input.

When the master asserts the slave select (SPI\_SSEL) signal, SPI transmit data is driven to the output pin SPI\_MISO, and SPI data is received from the input pin SPI\_MOSI. The SPI\_SSEL pin has to be asserted to enable the transmit serializer to drive data to the output signal SPI\_MISO. A rising edge on SPI\_SSEL causes the SPI\_MISO line to be tri-stated such that another slave device can drive it, if so desired.

If the output buffer is empty, the SPI serializer transmits the last valid bit repeatedly, which may be either high or low. Otherwise, the device formats all output in API mode 1 format, as described in [Operate in API mode](#). The attached host is expected to ignore all data that is not part of a formatted API frame.

## Force UART operation

If you configure a device with only the SPI enabled and no SPI master is available to access the SPI slave port, you can recover the device to UART operation by holding DIN / CONFIG low at reset time. DIN/CONFIG forces a default configuration on the UART at 9600 baud and brings up the device in Command mode on the UART port. You can then send the appropriate commands to the device to configure it for UART operation. If you write those parameters, the device comes up with the UART enabled on the next reset.

## Data format

SPI only operates in API mode 1. The XBee Smart Modem does not support Transparent mode or API mode 2 (which escapes control characters). This means that the AP configuration only applies to the UART, and the device ignores it while using SPI. The reason for this operation choice is that SPI is full duplex. If data flows in one direction, it flows in the other. Since it is not always possible to have valid data flowing in both directions at the same time, the receiver must have a way to parse out the valid data and to ignore the invalid data.

The XBee Smart Modem sends **0xFF** when there is no data to send to the host.

## File system

---

For detailed information about using MicroPython on the XBee Smart Modem refer to the [Digi MicroPython Programming Guide](#).

Overview of the file system .....	136
XCTU interface .....	137
Encrypt files .....	137

## Overview of the file system

XBee Smart Modem firmware versions ending in **0B** (for example, 1130B, 100B, 3100B) and later include support for storing files on an internal 1 MB SPI flash.



**CAUTION!** You need to [format the file system](#) if upgrading a device that originally shipped with older firmware. You can use XCTU, AT commands or MicroPython for that initial format or to erase existing content at any time.

**Note** To use XCTU with file system, you need XCTU 6.4.0 or newer.

See [ATFS FORMAT confirm](#) and ensure that the format is complete.

## Directory structure

The SPI flash appears in the file system as **/flash**, the only entry at the root level of the file system. It has a **lib** directory intended for MicroPython modules and a **cert** directory for files used for SSL/TLS sockets.

## Paths

The XBee Smart Modem stores all of its files in the top-level directory **/flash**. On startup, the **ATFS** commands and MicroPython each use that as their current working directory. When specifying the path to a file or directory, it is interpreted as follows:

- Paths starting with a forward slash are "absolute" and must start with **/flash** to be valid.
- All other paths are relative to the current working directory.
- The directory **..** refers to the parent directory, so an operation on **../filename.txt** that takes place in the directory **/flash/test** accesses the file **/flash/filename.txt**.
- The directory **.** refers to the current directory, so the command **ATFS ls .** lists files in the current directory.
- Names are case-insensitive, so **FILE.TXT**, **file.txt** and **FiLe.TxT** all refer to the same file.
- File and directory names are limited to 64 characters, and can only contain letters, numbers, periods, dashes and underscores. A period at the end of the name is ignored.
- The full, absolute path to a file or directory is limited to 255 characters.

## Secure files

The file system includes support for secure files with the following properties:

- Created via the **ATFS XPUT** command or in MicroPython using a mode of **\*** with the **open()** method.
- Unable to download via the **ATFS GET** command or MicroPython's **open()** method.
- SHA256 hash of file contents available from **ATFS HASH** command (to compare with a local copy of a file).
- Encrypted on the SPI flash.
- MicroPython can execute code in secure files.
- Sockets can use secure files when creating SSL/TLS connections.



## XCTU interface

XCTU releases starting with 6.4.0 include a **File System Manager** in the **Tools** menu. You can upload files to and download files from the device, in addition to renaming and deleting existing files and directories. See the [File System manager tool](#) section of the *XCTU User Guide* for details of its functionality.

## Encrypt files

You can encrypt files on the file system. This provides two things:

1. Protection of the client private key for SSL authentication while it is stored on the XBee Smart Modem.
2. Protection for user's MicroPython applications.

Use [ATFS XPUT filename](#) to place encrypted files on the file system. The XPUT operation is otherwise identical to the PUT operation. Files placed in this way are indicated with a **pound sign (#)** following the filename. The XBee Smart Modem does not allow an encrypted file to be read by normal use so it:

1. Cannot be retrieved with the GET operation.
2. Cannot be opened and read in MicroPython applications.
3. Cannot be created by a MicroPython application.

When [ATFS HASH filename](#) is run with the filename of an encrypted file, it reports the SHA256 hash of the file contents. In this way you can validate that the correct file has been placed on the XBee Smart Modem.

## Socket behavior

---

See [Socket leaks](#) for instances where a socket leaks when closing a connection while there is pending RX data.

**Note** For NB-IoT, TCP support is dependent on the network. Contact your network provider for details.

---

Supported sockets .....	139
Best practices when using sockets .....	139
Socket timeouts .....	139
Socket limits in API mode .....	140
Enable incoming TCP sockets in API mode .....	140
API mode behavior for outgoing TCP and SSL connections .....	140
API mode behavior for outgoing UDP data .....	141
API mode behavior for incoming TCP connections .....	141
API mode behavior for incoming UDP data .....	142
Transparent mode behavior for outgoing TCP and SSL connections .....	142
Transparent mode behavior for outgoing UDP data .....	143
Transparent mode behavior for incoming TCP connections .....	143
Transparent mode behavior for incoming UDP connections .....	143

## Supported sockets

The XBee Smart Modem supports the following number of sockets:

- 6 maximum: 4 SSL sockets maximum.<sup>1</sup>

---

**Note** For NB-IoT, TCP support is dependent on the network. Contact your network provider for details.

---

## Best practices when using sockets

### Sockets and Remote Manager

If you use Remote Manager to remotely communicate with and configure your XBee Cellular device, you must leave at least two sockets available in the system: one UDP socket (for periodic low-data-usage check-ins), and one TCP/TLS socket (to be used when a full connection is needed).

If your application allocates so many sockets that Remote Manager functionality in the firmware cannot get the sockets that it requires, Remote Manager functionality will be prevented from working until sockets become available.

For example, each call to `socket.socket()` in MicroPython will allocate a socket, and this socket will remain allocated to MicroPython until the socket's close method is called, or the MicroPython REPL is restarted using Ctrl-D.

See [Supported sockets](#) for more information on the total number of sockets supported by the device.

### Sockets and API mode

When using API mode to transmit TCP/TLS data to a remote destination (using the 0x20 or 0x23 API frames), sending a large amount of data as a single API frame is preferable to multiple smaller API frames. Using a single large API frame allows the XBee to transmit the data using fewer operations than transmitting multiple pieces of data in sequence, which improves overall throughput.

Additionally, one API frame consumes less dynamic memory in the system than multiple smaller API frames, which means there will be more memory available to process incoming IP data as well as subsequent API frames sent into the XBee Cellular device.

## Socket timeouts

The XBee Smart Modem implicitly opens the socket any time there is data to be sent, and closes it according to the timeout settings. The [TM \(IP Client Connection Timeout\)](#) command controls the timeout settings.

---

**Note** For NB-IoT, TCP support is dependent on the network. Contact your network provider for details.

---

---

<sup>11</sup> TCP socket is used for Remote Manager, so if you have Remote Manager enabled, subtract 1 socket from the values above.

## Socket limits in API mode

---

**Note** For NB-IoT, TCP support is dependent on the network. Contact your network provider for details.

---

In API mode there are a fixed number of sockets available; see [Supported sockets](#). When a [Transmit \(TX\) Request: IPv4 - 0x20](#) frame is sent to the XBee Smart Modem for a new destination, it creates a new socket. The exception to this is when using the UDP protocol with the C0 source port, which allows unlimited destinations on the socket created by [C0 \(Source Port\)](#). If no more sockets are available, the device sends back a [Transmit \(TX\) Status - 0x89](#) frame with a Resource Error. The Resource Error resolves when an existing socket is closed. An existing socket may be closed when the socket times out (see [TM \(IP Client Connection Timeout\)](#) and [TS \(IP Server Connection Timeout\)](#)) or when the socket is closed via a TX request with the CLOSE flag set.

In API mode each socket has a maximum number of pending Transmit (TX) Requests allowed. When a [Transmit \(TX\) Request: IPv4 - 0x20](#) frame is sent to the XBee Smart Modem for an existing destination, it sends that request using the socket for that destination. If the number of pending Transmit (TX) Requests would be exceeded for the socket, the device sends back a [Transmit \(TX\) Status - 0x89](#) frame with a Resource Error indicating that the device is not able to send the request and should retry again later. The Resource Error resolves when a Transmit (TX) Request that is pending on the socket is transmitted; this is indicated by the Transmit (TX) Status frame for the request.

## Enable incoming TCP sockets in API mode

In API mode, you can enable incoming connections to the XBee Smart Modem.

---

**Note** For NB-IoT, TCP support is dependent on the network. Contact your network provider for details.

---

1. To enable listening, set [C0 \(Source Port\)](#) to the value of the listening port.
2. To use TCP for client and server socket connections, set [IP \(IP Protocol\)](#) to **0x01**.

The listener allows multiple clients (incoming connections), up to the limit of the maximum number of sockets on the system.

When the XBee Smart Modem receives RF data on the port defined by **C0**, you get a [Receive \(RX\) Packet: IPv4 - 0xB0](#) with the incoming address and port.

If you want to communicate back to the incoming connection, use the [Transmit \(TX\) Request: IPv4 - 0x20](#) and enter the received address and port as the destination address and port, along with the listening (**C0**) local source port.

## API mode behavior for outgoing TCP and SSL connections

To initiate an outgoing TCP or SSL connection to a remote host, send a [Transmit \(TX\) Request: IPv4 - 0x20](#) frame to the XBee Smart Modem's serial port specifying the destination address and destination port for the remote host; the data is optional and the source port is **0**.

---

**Note** For NB-IoT, TCP support is dependent on the network. Contact your network provider for details.

---

If the connection is disconnected at any time, send a Transmit TX Request frame to trigger a new connection attempt.

To send data over this connection use the [Transmit \(TX\) Request: IPv4 - 0x20](#).

The device sends a [Transmit \(TX\) Status - 0x89](#) frame in reply to the Transmit TX Request indicating the status of the request. A status of **0** indicates the connection and/or data was successful, a value of 0x32 indicates a temporary Resource Error (see [Socket limits in API mode](#)), and other values indicates a failure.

Any data received on the connection is sent out the XBee Smart Modem's serial port as a Receive RX frame.

A connection is closed when:

- The remote end closes the connection.
- No data is sent or received for longer than the socket timeout set by [TM \(IP Client Connection Timeout\)](#).
- A Transmit TX Request is sent with the CLOSE flag set.

## API mode behavior for outgoing UDP data

To send a UDP datagram to a remote host, send a [Transmit \(TX\) Request: IPv4 - 0x20](#) frame to the XBee Smart Modem's serial port specifying the destination address and destination port of the remote host. If you use a source port of **0**, the device creates a new socket for the purpose of sending to the remote host. The XBee Smart Modem supports a finite number of sockets, so if you need to send to many destinations:

1. The socket must be closed after use.  
or
2. You must use the socket specified by the [C0 \(Source Port\)](#) setting.

To use the socket specified by the **C0** setting, in the Transmit TX request frame use a source port that matches the value configured for the **C0** setting.

The device sends a [Transmit \(TX\) Status - 0x89](#) frame in reply to the Transmit TX Request to indicate the status of the request. A status of **0** indicates the connection and/or data was successful, a value of 0x32 indicates a temporary Resource Error (see [Socket limits in API mode](#)), and other values indicates a failure.

Any data received on the UDP socket is sent out the XBee Smart Modem's serial port as a [Receive \(RX\) Packet: IPv4 - 0xB0](#) frame.

A UDP socket is closed when:

- No data has been sent or received for longer than the socket timeout set by [TM \(IP Client Connection Timeout\)](#).
- A transmit TX Request is sent with the CLOSE flag set.

## API mode behavior for incoming TCP connections

For incoming connections and data in API mode, the XBee Smart Modem uses the [C0 \(Source Port\)](#) and [IP \(IP Protocol\)](#) settings to specify the listening port and protocol used. The XBee Smart Modem does not currently support the SSL protocol for incoming connections.

---

**Note** For NB-IoT, TCP support is dependent on the network. Contact your network provider for details.

---

When the **IP** setting is TCP the XBee Smart Modem allows multiple incoming TCP connections on the port specified by the **C0** setting. Any data received on the connection is sent out the XBee Smart Modem's serial port as a [Receive \(RX\) Packet: IPv4 - 0xB0](#) frame.

To send data from the device over the connection, use the [Transmit \(TX\) Request: IPv4 - 0x20](#) frame with the corresponding address fields received from the Receive RX frame. In other words:

- Take the source address, source port, and destination port fields from the Receive (RX) frame and use those respectively as:
- The destination address, destination port, and source port fields for the Transmit (TX) Request frame.

A connection is closed when:

- The remote end closes the connection.
- No data has been sent or received for longer than the socket timeout set by [TS \(IP Server Connection Timeout\)](#).
- A Transmit (TX) Request frame is sent with the CLOSE flag set.

## API mode behavior for incoming UDP data

When the **IP (IP Protocol)** setting is UDP, any data sent from a remote host to the XBee Smart Modem's network port specified by the **C0 (Source Port)** setting is sent out the XBee Smart Modem's serial port as a [Receive \(RX\) Packet: IPv4 - 0xB0](#) frame.

To send data from the XBee Smart Modem to the remote destination, use the [Transmit \(TX\) Request: IPv4 - 0x20](#) frame with the corresponding address fields received from the Receive RX frame. In other words take the source address, source port, and destination port fields from the Receive (RX) frame and use those respectively as the destination address, destination port, and source port fields for the Transmit (TX) Request frame.

## Transparent mode behavior for outgoing TCP and SSL connections

For Transparent mode, the **IP (IP Protocol)** setting specifies the protocol and the **DL (Destination Address)** and **DE (Destination port)** settings specify the destination address used for outgoing data (UDP) and outgoing connections (TCP and SSL).

---

**Note** For NB-IoT, TCP support is dependent on the network. Contact your network provider for details.

---

To initiate an outgoing TCP or SSL connection to a remote host, send data to the XBee Smart Modem's serial port. If **CI (Protocol/Connection Indication)** reports a value of **0**, then the connection was successfully established, otherwise the value of **CI** indicates why the connection attempt failed. Any data received over the connection is sent out the XBee Smart Modem's serial port.

A connection is closed when:

- The remote end closes the connection.
- No data has been sent or received for longer than the socket timeout set by [TM \(IP Client Connection Timeout\)](#).
- You make and apply a change to the **IP**, **DL**, or **DE**.

## Transparent mode behavior for outgoing UDP data

To send outgoing UDP data to a remote host, send data to the XBee Smart Modem's serial port. If **CI** ([Protocol/Connection Indication](#)) reports a value of **0**, the data was successfully sent; otherwise, the value of **CI** indicates why the data failed to be sent.

The **RO** ([Packetization Timeout](#)) setting provides some control in how the serial data gets packetized before being sent to the remote host. The first send opens up a UDP socket used to send and receive data. Any data received by this socket is sent out the XBee Smart Modem's serial port.

---

**Note** Set **RO** to **FF** for realtime typing by humans. Also, see [TD \(Text Delimiter\)](#).

---

## Transparent mode behavior for incoming TCP connections

The **C0** ([Source Port](#)) and **IP** ([IP Protocol](#)) settings specify the listening port and protocol used for incoming connections (TCP) and incoming data (UDP) in Transparent mode. SSL is not currently supported for incoming connections.

---

**Note** For NB-IoT, TCP support is dependent on the network. Contact your network provider for details.

---

When the **IP** setting is TCP and there is no existing connection to or from the XBee Smart Modem, the device accepts one incoming connection. Any data received on the connection is sent out the XBee Smart Modem's serial port. Any data sent to the XBee Smart Modem's serial port is sent over the connection. If the connection is disconnected, it discards pending data.

## Transparent mode behavior for incoming UDP connections

When the **IP** ([IP Protocol](#)) setting is UDP any data sent from a remote host to the XBee Smart Modem's network port specified by **C0** ([Source Port](#)) is sent out the XBee Smart Modem's serial port. Any data sent to the XBee Smart Modem's serial port is sent to the network destination specified by the **DL** ([Destination Address](#)) and **DE** ([Destination port](#)) settings. If the **DL** and **DE** settings are unspecified or invalid, the XBee Smart Modem discards data sent to the serial port.

## Transport Layer Security (TLS)

---

For detailed information about using MicroPython on the XBee Smart Modem refer to the [Digi MicroPython Programming Guide](#).

---

**Note** For NB-IoT, TCP support is dependent on the network. Contact your network provider for details.

---

TLS AT commands .....	145
Transparent mode and TLS .....	146
API mode and TLS .....	146
Key formats .....	146
Certificate formats .....	146
Certificate limitations .....	146
Cipher suites .....	147
Server Name Indication (SNI) .....	147
Secure the connection between an XBee and Remote Manager with server authentication .....	147



## TLS AT commands

**Note** For NB-IoT, TCP support is dependent on the network. Contact your network provider for details.

These AT commands, when used together, let you interact with TLS features: [ATFS \(File System\)](#), [TL \(SSL/TLS Protocol Version\)](#), [IP \(IP Protocol\)](#), [\\$0 \(SSL/TLS Profile 0\)](#), [\\$1 \(SSL/TLS Profile 1\)](#), and [\\$2 \(SSL/TLS Profile 2\)](#). The format of the **\$** commands is:

**AT\$<num>[<ca\_cert>];[<client\_cert>];[<client\_key>]**

Where:

- **num**: Profile index. Index zero is used for Transparent mode connections and TLS connections using [Transmit \(TX\) Request: IPv4 - 0x20](#).
- **ca\_cert**: (optional) Filename of a file in the **certs/** directory. Indicates the certificate identifying a trusted root certificate authority (CA) to use in validating servers. If **ca\_cert** is empty the server certificate will not be authenticated. This must be a single root CA certificate. The modules do not allow a non-self signed certificate to work, so intermediate CAs are not enough.

**Note** This module will only work with the originating end of chain Root CA, so you will need to use that one. For example, with Amazon web services ATS endpoints Digi recommends that you use the Starfield Services Root Certificate from <https://www.amazontrust.com/repository/>. The intermediate "root CAs" from Amazon will not work. You will need the actual end of chain certificate.

- **client\_cert**: (optional) Filename of a file in the **certs/** directory. Indicates the certificate presented to servers when requested for client authentication. If **client\_cert** is empty no certificate is presented to the server should it request one. This may result in mutual authentication failure.
- **client\_key**: (optional) Filename of a file in the **certs/** directory. Indicates the private key matching the public key contained in **client\_cert**. This should be a secure file uploaded with [ATFS XPUT filename](#). This should always be provided if **client\_cert** is provided and match the certificate or client authentication will fail.

The default value is ";;". This default value preserves the legacy behavior by allowing the creation of encrypted connections that are confidential but not authenticated.

To specify a key stored outside of **certs/**, you can either use a relative path, for example **../server.pem** or an absolute path starting with **/flash**, for example **/flash/server.pem**. Both examples refer to the same file.

It is not an error at configuration time to name a file that does not yet exist. An error is generated if an attempt to create a TLS connection is made with improper settings.

- Files specified should all be in PEM format, not DER.
- Upload private keys securely with [ATFS XPUT filename](#).
- Certificates can be uploaded with [ATFS PUT filename](#) as they are not sensitive. It is not possible to use [ATFS GET filename](#) to **GET** them if they have been securely uploaded.

To authenticate a server not participating in a public key infrastructure (PKI) using CAs, the server must present a self-signed certificate. That certificate can be used in the **ca\_cert** field to authenticate that single server.

There are effectively three levels of authentication provided depending on the parameters provided

1. No authentication: None of the parameters are provided, this is the default value. With this configuration identity is not validated and a man in the middle (MITM) attack is possible.
2. Server authentication: Only **ca\_cert** is provided. Only the servers identity is checked
3. Mutual authentication: All items are provided and both sides are assured of the identity of their peer

It is not possible to only have client authentication.

## Transparent mode and TLS

Transparent mode connections made when **IP (IP Protocol) = 4** (TLS) are made using the configuration specified by [\\$0 \(SSL/TLS Profile 0\)](#).

---

**Note** For NB-IoT, TCP support is dependent on the network. Contact your network provider for details.

---

## API mode and TLS

On the [Transmit \(TX\) Request: IPv4 - 0x20](#) frame, when you specify protocol **4** (TLS), the profile configuration specified by [\\$0 \(SSL/TLS Profile 0\)](#) is used to form the TLS connection. [Tx Request with TLS Profile - 0x23](#) lets you choose the IP setting for the serial data.

---

**Note** For NB-IoT, TCP support is dependent on the network. Contact your network provider for details.

---

## Key formats

The RSA PKCS#1 format is the only common format across XBee Cellular device variants. You can identify a PKCS#1 key file by the presence of **BEGIN RSA PRIVATE KEY** in the file header.

Digi's implementation does not support encrypted keys, we use file system encryption to protect the keys at rest in the system.

---

**Note** For NB-IoT, TCP support is dependent on the network. Contact your network provider for details.

---

## Certificate formats

For SARA-R410 cellular components used in the XBee3 Cellular LTE-M Global Smart Modem, if the server certificate has a Common Name (CN) that is greater than 31 characters the SSL connection fails.

---

**Note** For NB-IoT, TCP support is dependent on the network. Contact your network provider for details.

---

## Certificate limitations

The XBee Smart Modem only supports certificate files that contain a single certificate in them.

---

**Note** For NB-IoT, TCP support is dependent on the network. Contact your network provider for details.

---

The implications of this are:

- For client certificate files (for example when client authentication is required):
  - Self-signed certificates will work.
  - Certificates signed by the root CA will work, because the root CA can be omitted per RFC 5246. The root certificate authority may be omitted from the chain, under the assumption that the remote end must already possess it in order to validate it in any case.
  - Certificate chains that include an intermediate CA are problematic. To work around this the client's certificate chain has to be supplied to the server outside of the connection.
- For server certificate files (when server authentication is required) this is not a problem unless the client is expected to connect to multiple servers that are using different self signed certificates or are using certificate chains that are signed by different root CA certificates. To work around this you have to change the certificates before making the connection, or in the case of API mode specify a different authentication profile.

## Cipher suites

---

**Note** For NB-IoT, TCP support is dependent on the network. Contact your network provider for details.

---

The only documented shared suites between the XBee3 Cellular LTE Cat 1 Smart Modem and the XBee3 Cellular LTE-M Global Smart Modem are:

- TLS\_RSA\_WITH\_AES\_128\_CBC\_SHA
- TLS\_RSA\_WITH\_AES\_256\_CBC\_SHA

For the u-blox SARA-R410 and SARA-U201 cellular components:

- TLS\_RSA\_WITH\_AES\_128\_CBC\_SHA
- TLS\_RSA\_WITH\_AES\_128\_CBC\_SHA256
- TLS\_RSA\_WITH\_AES\_256\_CBC\_SHA
- TLS\_RSA\_WITH\_AES\_256\_CBC\_SHA256
- TLS\_RSA\_WITH\_3DES\_EDE\_CBC\_SHA

## Server Name Indication (SNI)

We do not currently support SNI. Therefore servers which use SNI to present certificates based on client provided host data may be unable to establish the expected connections.

## Secure the connection between an XBee and Remote Manager with server authentication

The XBee devices that have the x11 or later version of the firmware installed are by default able to secure the TLS connection to Digi Remote Manager. The default configuration provides confidentiality of the communication but is not able to authenticate the server without a certificate being provided.

If you have devices that have been upgraded in the field or manufactured prior to being pre-populated with the Remote Manager certificate, you should follow the procedure below to add the necessary certificate if server authentication is needed.

## Step 1: Get the certificate

1. Navigate to the **Firmware Updates** section of the [Digi XBee3 Cellular LTE-M/NB-IoT support page](#).
2. Click **Remote Manager TLS Public Certificate** to download the certificate .zip file.
3. Unzip the .zip file.
4. Calculate the SHA-256 hash to verify that the file is correct. The correct file will have an SHA-256 hash of:  
33d91e18668b0d8a9ec59c5f9f312c53ca2884adaa62337839e5495c26d2d64c

## Step 2: Configure device

You should confirm that the default settings are correct. You can use either Remote Manager or XCTU to verify these settings and place the certificate file in the correct location.

1. Verify the following settings:

Setting	Value
<b>DO</b>	Bit 0 (mask 0x1) must be set. This enables the use of Digi Remote Manager within the firmware.
<b>MO</b>	Bit 1 (mask 0x2) must be set. When this value is set the Remote Manager TCP connection will be secured with TLS.
<b>\$D</b>	By default will contain the value <code>/flash/cert/digi-remote-mgr.pem</code> . This is the file system location where the firmware will look for the certificate to use.

2. Use XCTU or Remote Manager to place the downloaded and unzipped certificate file in the location specified in the **\$D** command.

## Step 3: Verify that authentication is being performed

The next TCP connection to Remote Manager should only succeed if the server can be authenticated using the provided certificate. You can confirm that the server has been authenticated.

1. Cause an active connection to Remote Manager. For example, you could set bit 0 for the **MO** command. Make sure that you do not clear bit 1.
2. After a short wait you should be able to see the device as connected in Remote Manager.
  - a. [Log in to Remote Manager](#).
  - b. Click **Device Management**.
  - c. Locate the device in the device list and verify that the connection icon in the left column is blue and the hover tool tip says "Connected".

3. When the device is connected to Remote Manager, the **DI** command can take on any of the three values shown below, based on the security level of the connection. Verify that the **DI** command is set to **6** to verify that the server was correctly authenticated.
  - **0**: Connected without TLS
  - **5**: Connected with TLS but without authentication
  - **6**: Connected with TLS and with authentication

## AT commands

---

Special commands .....	151
Cellular commands .....	153
Network commands .....	158
Addressing commands .....	162
Serial interfacing commands .....	165
I/O settings commands .....	168
I/O sampling commands .....	176
Sleep commands .....	178
Command mode options .....	180
MicroPython commands .....	182
Firmware version/information commands .....	184
Diagnostic interface commands .....	186
Execution commands .....	189
File system commands .....	190
BLE commands .....	193
Remote Manager commands .....	195
System commands .....	198

## Special commands

The following commands are special commands.

### AC (Apply Changes)

Immediately applies new settings without exiting Command mode.

Applying changes means that the device re-initializes based on changes made to its parameter values. Once changes are applied, the device immediately operates according to the new parameter values.

This behavior is in contrast to issuing the **WR** (Write) command. The **WR** command saves parameter values to non-volatile memory, but the device still operates according to previously saved values until the device is rebooted or you issue the **CN** (Exit AT Command Mode) or **AC** commands.

#### Parameter range

N/A

#### Default

N/A

### FR (Force Reset)

Resets the device. The device responds immediately with an **OK** and performs a reset 100 ms later.

If you issue **FR** while the device is in Command Mode, the reset effectively exits Command mode.

---

**Note** We recommend entering Airplane mode before resetting or rebooting the device to allow the cellular module to detach from the network.

---

#### Parameter range

N/A

#### Default

N/A

### RE (Restore Defaults)

Restore device parameters to factory defaults.

The **RE** command does not write restored values to non-volatile (persistent) memory. Issue the **WR** (Write) command after issuing the **RE** command to save restored parameter values to non-volatile memory.

#### Parameter range

N/A

#### Default

N/A

### WR (Write)

Writes parameter values to non-volatile memory so that parameter modifications persist through subsequent resets.

---

**Note** Once you issue a **WR** command, do not send any additional characters to the device until after you receive the **OK** response.

---

**Parameter range**

N/A

**Default**

N/A



## Cellular commands

The following AT commands are cellular configuration and data commands.

### PH (Phone Number)

Reads the SIM card phone number.

**Parameter range**

N/A

**Default**

Set by the cellular carrier via the SIM card

### S# (ICCID)

Reads the Integrated Circuit Card Identifier (ICCID) of the inserted SIM.

**Parameter range**

N/A

**Default**

Set by the SIM card

### IM (IMEI)

Reads the device's International Mobile Equipment Identity (IMEI).

**Parameter range**

N/A

**Default**

Set in the factory

### MN (Operator)

Reads the network operator on which the device is registered.

**Parameter range**

N/A

**Default**

N/A

### MV (Modem Firmware Version)

Read the firmware version string for cellular component communications. See the related [VR \(Firmware Version\)](#) command.

**Parameter range**

N/A

**Default**

Set in the currently loaded firmware

**DB (Cellular Signal Strength)**

Reads the absolute value of the current signal strength to the cell tower in dB. If **DB** is blank, the XBee Smart Modem has not received a signal strength from the cellular component.

DB only updates when the modem is registered with the cellular tower. It is updated periodically, and not when read.

**Parameter range**

0x71 - 0x33 (-113 dBm to -51 dBm) [read-only]

**Default**

N/A

**AN (Access Point Name)**

Specifies the packet data network that the modem uses for Internet connectivity. This information is provided by your cellular network operator. After you set this value, applying changes with [AC \(Apply Changes\)](#) or [CN \(Exit Command mode\)](#) triggers a network reset.

See [Network connection issues](#) if the XBee Smart Modem is not joining the network.

**Parameter range**

1 - 100 ASCII characters

**Default**

-

**CP (Carrier Profile)**

Configures the cellular component to select network operator settings (RF bands, packet data configuration) for various networks.

The default setting of **0** (autodetect) increases the boot time.

The **1 (No Profile)** setting should be used if the module is not able to join the network because the underlying cellular modem does not have a predefined profile that supports the inserted SIM card. The **1 (No Profile)** setting does not use any predefined profiles, which forces the module to attempt to join an appropriate network based on the module's current configuration.

Changes to the value only take effect on boot so a reboot or power cycle is required for any changes to become active.

**Parameter range**

0 - 3

Value	Description
0	Autodetect from inserted ICCID (SIM) [default]

Value	Description
1	No Profile
2	AT&T
3	Verizon

**Default**

0

### BM (Bandmask) (LTE-M)

**Note** This command is for use with only LTE-M.

Configures the enabled 4G LTE bands for LTE-M when CP is set to **1** (No Profile).

Changes to the value only take effect on boot so a reboot or power cycle is required for any changes to become active.

**Note** The actual set of enabled bands will be a subset of this bit field, depending on the limitations of the cellular component.



**WARNING!** If this value is configured incorrectly, the XBee module may be unable to locate a tower and join the network.

**Parameter range**

0 - 0xFFFFFFFFFFFFFFFFFFFFFFFFFFFFFFFF (bit field)

Example: 0x080080 (bits 7 and 19) enable LTE Bands 8 and 20.

Bit	LTE Band
0	1
...	
127	128

**Default**

0xFFFFFFFFFFFFFFFF (bands 1-64 enabled)

### BN (Bandmask) (NB-IoT)

**Note** This command is for use with only NB-IoT.

Configures the enabled 4G LTE bands for NB-IoT when the CP command is set to **1** (No Profile). If CP is not set to **1**, the BN command will return an error.

Changes to the value only take effect on boot so a reboot or power cycle is required for any changes to become active.

---

**Note** The actual set of enabled bands will be a subset of this bit field, depending on the limitations of the cellular component.

---



**WARNING!** If this value is configured incorrectly, the XBee module may be unable to locate a tower and join the network.

---

**Parameter range**

0 - 0xFFFFFFFFFFFFFFFFFFFFFFFFFFFFFFFF (bit field)

Example: 0x080080 (bits 7 and 19) enable NB-IoT Bands 8 and 20.

Bit	LTE Band
0	1
...	
127	128

**Default**

0xFFFFFFFFFFFFFFFF (bands 1-64 enabled)

**AM (Airplane Mode)**

When set, the cellular component of the XBee Smart Modem is fully turned off and no access to the cellular network is performed or possible.

**Parameter range**

0 - 1

0 = Normal operation

1 = Airplane mode

**Default**

0

**N# (Preferred Network Technology)**

---

**Note** This command applies only to XBee3 Cellular LTE-M/NB-IoT.

---

Allows the XBee Cellular LTE-M/NB-IoT module to select the preferred network technology. A reboot or power cycle is required for any parameter changes to become active.

**Range**

0 - 3

Parameter	Description
0	LTE-M with NB-IoT fallback.
1	NB-IoT with LTE-M fallback.
2	LTE-M only.
3	NB-IoT only.

**Default**

0

## Network commands

The following commands are network commands.

### IP (IP Protocol)

**Note** For NB-IoT, TCP and SMS support is dependent on the network. Contact your network provider for details.

Sets or displays the IP protocol used for client and server socket connections in IP socket mode.

For TLS, the ublox [SARA-R4 series AT Commands Manual](#) provides the list of supported cipher suites under the **SSL/TLS security layer profile manager +USECPRF** heading.

#### Parameter range

0 - 4

Value	Description
0x00	UDP
0x01	TCP
0x02	SMS (Transparent mode)
0x03	Reserved
0x04	SSL over TCP

#### Default

0x01

### TL (SSL/TLS Protocol Version)

Sets the SSL/TLS protocol version used for the SSL socket. If you change the **TL** value, it does not affect any currently open sockets. The value only applies to subsequently opened sockets.

**Note** Due to known vulnerabilities in prior protocol versions, we strongly recommend that you use the latest TLS version whenever possible.

**Note** For NB-IoT, TCP support is dependent on the network. Contact your network provider for details.

#### Range

Value	Description
0x00	SSL v3
0x01	TLS v1.0
0x02	TLS v1.1
0x03	TLS v1.2

**Default**

0x03

**\$0 (SSL/TLS Profile 0)**

Specifies the SSL/TLS certificate(s) to use in Transparent mode (when [IP \(IP Protocol\) = 4](#)) or API mode ([Transmit \(TX\) Request: IPv4 - 0x20](#) or [Tx Request with TLS Profile - 0x23](#) with profile set to **0**).

---

**Note** For NB-IoT, TCP support is dependent on the network. Contact your network provider for details.

---

**Format****server\_cert;client\_cert;client\_key****Parameter range**

From 1 through 127 ASCII characters.

**Default**

N/A

**\$1 (SSL/TLS Profile 1)**

Specifies the SSL/TLS certificate(s) to use for [Tx Request with TLS Profile - 0x23](#) transmissions with profile set to **1**.

---

**Note** For NB-IoT, TCP support is dependent on the network. Contact your network provider for details.

---

**Format****server\_cert;client\_cert;client\_key****Parameter range**

From 1 through 127 ASCII characters.

**Default**

N/A

**\$2 (SSL/TLS Profile 2)**

Specifies the SSL/TLS certificate(s) to use in Transparent mode (when [IP \(IP Protocol\) = 4](#)) or API mode ([Transmit \(TX\) Request: IPv4 - 0x20](#) or [Tx Request with TLS Profile - 0x23](#) with profile set to **0**).

---

**Note** For NB-IoT, TCP support is dependent on the network. Contact your network provider for details.

---

**Format****server\_cert;client\_cert;client\_key****Parameter range**

From 1 through 127 ASCII characters.

**Default**

N/A

**TM (IP Client Connection Timeout)**

The IP client connection timeout. If there is no activity for this timeout then the connection is closed. If **TM** is **0**, the connection is closed immediately after the device sends data.

If you change the **TM** value while in Transparent Mode, the current connection is immediately closed. Upon the next transmission, the **TM** value applies to the newly created socket.

If you change the **TM** value while in API Mode, the value only applies to subsequently opened sockets.

---

**Note** For NB-IoT, TCP support is dependent on the network. Contact your network provider for details.

---

**Parameter range**

0 - 0xFFFF [x 100 ms]

**Default**

0xBB8 (5 minutes)

**TS (IP Server Connection Timeout)**

The IP server connection timeout. If no activity for this timeout then the connection is closed. When set to **0** the connection is closed immediately after data is sent.]

---

**Note** For NB-IoT, TCP support is dependent on the network. Contact your network provider for details.

---

**Parameter Range**

10 - 0xFFFF; (x 100 ms)

**Default**

0xBB8 (5 minutes)

**DO (Device Options)**

Enables and disables special features on the XBee Smart Modem.

---

**Note** For NB-IoT, TCP support is dependent on the network. Contact your network provider for details.

---

**Bit 0 - Remote Manager support**

If the XBee Smart Modem cannot establish a connection with Remote Manager, it waits 30 seconds before trying again. On each successive connection failure, the wait time doubles (60 seconds, 120, 240, and so on) up to a maximum of 1 hour. This time resets to 30 seconds once the connection to Remote Manager succeeds or if the device is reset.

**Bit 2 - USB direct enable**

Set bit 2 to enable USB direct mode. After setting, use [WR \(Write\)](#) to write all values to flash and use [FR \(Force Reset\)](#) to reset the device.



---

**Note** Setting **P0 (DIO10/PWM0 Configuration)** to **6** overrides setting **DO** bit 2.

---

### Bit 3 - PSM

To enable PSM, set **DO (Device Options)** bit 3. See **Power Saving Mode (PSM)** for details.

#### Range

0x00 - 0x0F

#### Bitfield

Bit	Description
0x00	Enable Remote Manager
0x02	Enable USB Direct
0x03	Enable PSM

---

**Note** We strongly recommend that you clear bit 0 (Enable Remote Manager) if you set bit 3. If not, the connection that the device retains with Remote Manager causes the cellular component to spend very little time in low power, negating the value of selecting that feature.

---

#### Default

0x01 (Bit 0 enabled)

## DT (Cellular Network Time)

Reads the current network-provided local time of the XBee device.

If the time is not known, the response is empty. This value is synchronized with the network approximately once per hour.

#### Parameter range

0 - 1

Value	Description
0	The response is the number of seconds since 2000-01-01 00:00:00 UTC, as a 32-bit number. This is the default.
1	The response is the current date and time in ISO 8601 format. For example, "2018-12-25T22:00:05".

---

**Note** You can also send **DT**, which acts like **DT=0**.

---

#### Default

0

## Addressing commands

The following AT commands are addressing commands.

### SH (Serial Number High)

The upper digits of the unique International Mobile Equipment Identity (IMEI) assigned to this device.

**Parameter range**

0 - 0xFFFFFFFF [read-only]

**Default**

N/A

### SL (Serial Number Low)

The lower digits of the unique International Mobile Equipment Identity (IMEI) assigned to this device.

**Parameter range**

0 - 0xFFFFFFFF [read-only]

**Default**

N/A

### MY (Module IP Address)

Reads the device's IP address. This command is read-only because the IP address is assigned by the mobile network.

In API mode, the address is represented as the binary four byte big-endian numeric value representing the IPv4 address.

In Transparent or Command mode, the address is represented as a dotted-quad string notation.

**Parameter range**

0- 15 IPv4 characters

**Default**

0.0.0.0

### P# (Destination Phone Number)

Sets or displays the destination phone number used for SMS when [IP \(IP Protocol\) = 2](#). Phone numbers must be fully numeric, 7 to 20 ASCII digits, for example: 8889991234.

**P#** allows international numbers with or without the + prefix. If you omit + and are dialing internationally, you need to include the proper International Dialing Prefix for your calling region, for example, 011 for the United States.

**Range**

7 - 20 ASCII digits including an optional + prefix

**Default**

N/A

## N1 (DNS Address)

Displays the IPv4 address of the primary domain name server.

### Parameter Range

Read-only

### Default

0.0.0.0 (waiting on cellular connection)

## N2 (DNS Address)

Displays the IPv4 address of the secondary domain name server.

### Parameter Range

Read-only

### Default

0.0.0.0 (waiting on cellular connection)

## DL (Destination Address)

The destination IPv4 address or fully qualified domain name.

To set the destination address to an IP address, the value must be a dotted quad, for example **XXX.XXX.XXX.XXX**.

To set the destination address to a domain name, the value must be a legal Internet host name, for example **remotemanager.digi.com**

### Parameter range

0 - 128 ASCII characters

### Default

0.0.0.0

## OD (Operating Destination Address)

Read the destination IPv4 address currently in use by Transparent mode. The value is **0.0.0.0** if no Transparent IP connection is active.

In API mode, the address is represented as the binary four byte big-endian numeric value representing the IPv4 address.

In Transparent or Command mode, the address is represented as a dotted-quad string notation.

### Parameter range

-

### Default

0.0.0.0

### DE (Destination port)

Sets or displays the destination IP port number.

This command reads all input as hexadecimal. All values must be entered in hexadecimal with no leading 0x. For example, the destination port 9001 has the hexadecimal value of 0x2329. The command would be entered as **ATDE 2329**.

#### Parameter range

0x0 - 0xFFFF

#### Default

0x2616

### C0 (Source Port)

Set or get the port number used to provide the serial communication service. Data received by this port on the network is transmitted on the XBee Smart Modem's serial port.

As long as a network connection is established to this port (for TCP) data received on the serial port is transmitted on the established network connection.

[IP \(IP Protocol\)](#) sets the protocol used when UART is in Transparent or API mode.

For more information on using incoming connections, see [Socket behavior](#).

#### Parameter range

0 - 0xFFFF

Value	Description
0	Disabled
Non-0	Enabled on that port

#### Default

0

### LA (Lookup IP Address of FQDN)

Performs a DNS lookup of the given fully qualified domain name (FQDN) and outputs its IP address.

When you issue **LA** in API mode, the IP address is formatted in binary four byte big-endian numeric value. In all other cases (for example, Command mode) the format is dotted decimal notation.

#### Range

Valid FQDN

#### Default

-

## Serial interfacing commands

The following AT commands are serial interfacing commands.

### BD (Baud Rate)

Sets or displays the serial interface baud rate for communication between the device's serial port and the host.

Modified interface baud rates do not take effect until the XBee Smart Modem exits Command mode or you issue [AC \(Apply Changes\)](#). The baud rate resets to default unless you save it with [WR \(Write\)](#) or by clicking the **Write module settings** button in XCTU.

#### Parameter range

Standard baud rates: 0x1 - 0x8

Non-standard baud rates: 0x5B9 to 0x3D090 (250,000 b/s)

Parameter	Description
0x0	1200 b/s
0x1	2400 b/s
0x2	4800 b/s
0x3	9600 b/s
0x4	19200 b/s
0x5	38400 b/s
0x6	57600 b/s
0x7	115200 b/s
0x8	230400 b/s

#### Default

0x3 (9600 b/s)

### NB (Parity)

Set or read the serial parity settings for UART communications.

#### Parameter range

0x00 - 0x02

Parameter	Description
0x00	No parity
0x01	Even parity
0x02	Odd parity

**Default**

0x00

**SB (Stop Bits)**

Sets or displays the number of stop bits for UART communications.

**Parameter range**

0 - 1

Parameter	Configuration
0	One stop bit
1	Two stop bits

**Default**

0

**RO (Packetization Timeout)**

Set or read the number of character times of inter-character silence required before transmission begins when operating in Transparent mode.

RF transmission also starts after 100 bytes (maximum packet size) are received in the **DI** buffer.

Set **RO** to **0** to transmit characters as they arrive instead of buffering them into one RF packet.

**Parameter range**

0 - 0xFF (x character times)

**Default**

3

**TD (Text Delimiter)**

The ASCII character used as a text delimiter for Transparent mode. When you select a character, information received over the serial port in Transparent mode is not transmitted until that character is received. To use a carriage return, set to **0xD**. Set to zero to disable text delimiter checking.

**Parameter range**

0 - 0xFF

**Default**

0x0

**FT (Flow Control Threshold)**

Set or display the flow control threshold.

The device de-asserts  $\overline{\text{CTS}}$  when **FT** bytes are in the UART receive buffer.

**Parameter range**

0x9D - 0x82D

**Default**

0x681

**AP (API Enable)**

Enables the frame-based application programming interface (API) mode.

The API mode setting. The device can format the RF packets it receives into API frames and send them out the UART. When API is enabled the UART data must be formatted as API frames because Transparent mode is disabled. See [Modes](#) for more information.

**Parameter range**

0x00 - 0x05

Parameter	Description
0x00	API disabled (operate in Transparent mode)
0x01	API enabled
0x02	API enabled (with escaped control characters)
0x03	N/A
0x04	MicroPython REPL
0x05	Bypass mode

**Default**

0

## I/O settings commands

The following AT commands are I/O settings commands.

### DO (DIO0/AD0)

Sets or displays the DIO0/AD0 configuration (pin 20).

#### Parameter range

0, 2 - 5

Parameter	Description
0	Disabled
1	N/A
2	Analog input
3	Digital input
4	Digital output, default low
5	Digital output, default high

#### Default

0

### D1 (DIO1/AD1)

Sets or displays the DIO1/AD1 configuration (pin 19).

#### Parameter range

0 - 6

Parameter	Description
0	Disabled
1	SPI_ATTN
2	ADC
3	Digital input
4	Digital output, low
5	Digital output, high
6	I2C SCL

#### Default

0



**D2 (DIO2/AD2)**

Sets or displays the DIO2/AD2 configuration (pin 18).

**Parameter range**

0 - 5

	Description
0	Disabled
1	SPI_CLK
2	Analog input
3	Digital input
4	Digital output, default low
5	Digital output, default high

**Default**

0

**D3 (DIO3/AD3)**

Sets or displays the DIO3/AD3 configuration (pin 17).

**Parameter range**

0 - 5

Parameter	Description
0	Disabled
1	SPI_SSEL
2	Analog input
3	Digital input
4	Digital output, default low
5	Digital output, default high

**Default**

0

**D4 (DIO4)****Parameter range****Default**

0

**D5 (DIO5/ASSOCIATED\_INDICATOR)**

Sets or displays the DIO5/ASSOCIATED\_INDICATOR configuration (pin 15).

**Parameter range**

0, 1, 3 - 5

Parameter	Description
0	Disabled
1	Associated LED
2	N/A
3	Digital input
4	Digital output, default low
5	Digital output, default high

**Default**

1

**D6 (DIO6/RTS)**

Sets or displays the DIO6/ $\overline{\text{RTS}}$  configuration (pin 16).

**Parameter range**

0, 1, 3 - 5

Parameter	Description
0	Disabled
1	$\overline{\text{RTS}}$ flow control
2	N/A
3	Digital input
4	Digital output, default low
5	Digital output, default high

**Default**

0

**D7 (DIO7/CTS)**

Sets or displays the DIO7/ $\overline{\text{CTS}}$  configuration (pin 12).

**Parameter range**

0, 1, 3 - 5

Parameter	Description
0	Disabled
1	$\overline{\text{CTS}}$ flow control
2	N/A
3	Digital input
4	Digital output, default low
5	Digital output, default high

**Default**

0x1

**D8 (DIO8/SLEEP\_REQUEST)**Sets or displays the DIO8/ $\overline{\text{DTR}}$ /SLP\_RQ configuration (pin 9).**Parameter range**

0, 1, 3 - 5

Parameter	Description
0	Disabled
1	SLEEP_REQUEST input
3	Digital input
4	Digital output, default low
5	Digital output, default high

**Default**

1

**D9 (DIO9/ON\_SLEEP)**Sets or displays the DIO9/ $\overline{\text{ON\_SLEEP}}$  configuration (pin 13).**Parameter range**

0, 1, 3 - 5

Parameter	Description
0	Disabled
1	$\overline{\text{ON\_SLEEP}}$ output
3	Digital input

Parameter	Description
4	Digital output, default low
5	Digital output, default high

**Default**

1

**P0 (DIO10/PWM0 Configuration)**

Sets or displays the PWM/DIO10 configuration (pin 6).

This command enables the option of translating incoming data to a PWM so that the output can be translated back into analog form.

**Parameter range**

0 - 6

Parameter	Description
0	Disabled
1	RSSI PWM0 output
2	PWM0 output
3	Digital input
4	Digital output, low
5	Digital output, high
6	USB VBUS

**Default**

0

**P1 (DIO11/PWM1 Configuration)**

Sets or displays the DIO11 configuration (pin 7).

**Parameter range**

0, 1, 3 - 7

Parameter	Description
0	Disabled
1	Fan enable. Output is low when the XBee Smart Modem is sleeping, turning an attached fan off when the cellular component is in a power saving mode, and also during Airplane Mode

Parameter	Description
3	Digital input
4	Digital output, default low
5	Digital output, default high
6	I2C SDA
7	USB direct

**Default**

0

**P2 (DIO12 Configuration)**

Sets or displays the DIO12 configuration (pin 4).

**Parameter range**

0, 1, 3 - 5

Parameter	Description
0	Disabled
1	SPI_MISO
2	N/A
3	Digital input
4	Digital output, default low
5	Digital output, default high

**Default**

0

**P3 (DIO13/DOUT)**

Sets or displays the DIO13/DOUT configuration (pin 17).

**Parameter range**

0, 1

Parameter	Description
0	Disabled
1	UART DOUT enabled

**Default**

1

### P4 (DIO14/DIN)

Sets or displays the DIO14/DIN configuration (pin 3).

**Parameter range**

0 - 1

Parameter	Description
0	Disabled
1	UART DIN enabled

**Default**

1

### PD (Pull Direction)

The resistor pull direction bit field (**1** = pull-up, **0** = pull-down) for corresponding I/O lines that are set by [PR \(Pull-up/down Resistor Enable\)](#).

If the bit is not set in **PR**, the device uses **PD**.

---

**Note** Resistors are not applied to disabled lines.

---

See [PR \(Pull-up/down Resistor Enable\)](#) for bit mappings, which are the same.

**Parameter range**

0x0 – 0x7FFF

**Default**

0 – 0x7FFF

### PR (Pull-up/down Resistor Enable)

Sets or displays the bit field that configures the internal resistor status for the digital input lines. Internal pull-up/down resistors are not available for digital output pins, analog input pins, or for disabled pins.

Use the **PD** command to specify whether the resistor is pull-up or pull-down.

- If you set a **PR** bit to 1, it enables the pull-up/down resistor.
- If you set a **PR** bit to 0, it specifies no internal pull-up/down resistor.

The following table defines the bit-field map for both the **PR** and **PD** commands.

Bit	I/O line	Module pin
0	DIO4	pin 11
1	DIO3/AD3	pin 17

Bit	I/O line	Module pin
2	DIO2/AD2	pin 18
3	DIO1/AD1	pin 19
4	DIO0/AD0	pin 20
5	DIO6/ $\overline{\text{RTS}}$	pin 16
6	DIO8/SLEEP_REQUEST	pin 9
7	DIO14/DIN	pin 3
8	DIO5/ASSOCIATE	pin 15
9	DIO9/On/ $\overline{\text{SLEEP}}$	pin 13
10	DIO12	pin 4
11	DIO10	pin 6
12	DIO11	pin 7
13	DIO7/ $\overline{\text{CTS}}$	pin 12
14	DIO13/DOUT	pin 17

**Parameter range**

0 - 0x7FFF (bit field)

**Default**

0x7FFF

**M0 (PWM0 Duty Cycle)**

Sets the duty cycle of PWM0 (pin 6) for **P0 = 2**, where a value of 0x200 is a 50% duty cycle.

Before setting the line as an output:

1. Enable PWM0 output ([P0 \(DIO10/PWM0 Configuration\)](#) = **2**).
2. Apply the settings (use [CN \(Exit Command mode\)](#) or [AC \(Apply Changes\)](#)).

The PWM period is 42.62  $\mu\text{s}$  and there are 0x03FF (1023 decimal) steps within this period. When **M0 = 0** (0% PWM), **0x01FF** (50% PWM), **0x03FF** (100% PWM), and so forth.

**Parameter range**

0 - 0x3FF

**Default**

0

## I/O sampling commands

The following AT commands configure I/O sampling parameters.

### TP (Temperature)

Displays the temperature of the XBee Smart Modem in degrees Celsius. The temperature value is displayed in 8-bit two's complement format. For example, **0x1A** = 26 °C, and **0xF6** = -10 °C.

#### Parameter range

0 - 0xFF which indicates degrees Celsius displayed in 8-bit two's complement format.

#### Default

N/A

### IS (Force Sample)

When run, **IS** reports the values of all of the enabled digital and analog input lines. If no lines are enabled for digital or analog input, the command returns an error.

#### Command mode

In Command mode, the response value is a multi-line format, individual lines are delimited with carriage returns, and the entire response terminates with two carriage returns. Each line is a series of ASCII characters representing a single number in hexadecimal notation. The interpretation of the lines is:

- Number of samples. For legacy reasons this field always returns 1.
- Digital channel mask. A bit-mask of all I/O capable pins in the system. The bits set to **1** are configured for digital I/O and are included in the digital data value below. Pins D0 - D9 are bits 0 - 9, and P0 - P2 are bits 10 - 12.
- Analog channel mask. The bits set to **1** are configured for analog I/O and have individual readings following the digital data field.
- Digital data. The current digital value of all the pins set in the digital channel mask, only present if at least one bit is set in the digital channel mask.
- Analog data. Additional lines, one for each set pin in the analog channel mask. Each reading is a 10-bit ADC value for a 2.5 V voltage reference.

#### API operating mode

In API operating mode, **IS** immediately returns an **OK** response.

The API response is ordered identical to the Command mode response with the same fields present. Each field is a binary number of the size listed in the following table. Multi-byte fields are in big-endian byte order.

Field	Size
Number of samples	1 byte
Digital channel mask	2 bytes



Field	Size
Analog channel mask	1 byte
Samples	2 bytes each

**Parameter range**

N/A

**Default**

N/A

## Sleep commands

The following AT commands are sleep commands.

### SM (Sleep Mode)

Sets or displays the sleep mode of the device.

The sleep mode determines how the device enters and exits a power saving sleep.

#### Parameter range

0, 1, 4, 5

Parameter	Description
0	Normal. In this mode the device never sleeps.
1	Pin Sleep. In this mode the device honors the SLEEP_RQ pin. Set <a href="#">D8 (DIO8/SLEEP_REQUEST)</a> to the sleep request function: <b>1</b> .
4	Cyclic Sleep. In this mode the device repeatedly sleeps for the value specified by <b>SP</b> and spends <b>ST</b> time awake.
5	Cyclic Sleep with Pin Wake. In this mode the device acts as in Cyclic Sleep but does not sleep if the SLEEP_RQ pin is inactive, allowing the device to be kept awake or woken by the connected system.

#### Default

0

### SP (Sleep Period)

Sets or displays the time to spend asleep in cyclic sleep modes. In Cyclic sleep mode, the node sleeps with CTS disabled for the sleep time interval, then wakes for the wake time interval.

#### Parameter range

0x1 - 0x83D600 (x 10 ms)

#### Default

0x7530 (5 minutes)

### ST (Wake Time)

Sets or displays the time to spend awake in cyclic sleep modes.

#### Parameter range

0x1 - 0x36EE80 (x 1 ms)

#### Default

0xEA60 (60 seconds)

## PA (Requested Active Timer)

The requested Active Timer for PSM.

---

**Note** This is related to [3GPP](#) timer T3324.

---

**Note** For NB-IoT, TCP support is dependent on the network. Contact your network provider for details.

---

### Parameter range

0 - 0xFFFF (0 - 65535 [\* 1 s])

### Default

0xa (10 s)

## PU (Requested Tracking Area Update Timer)

The requested Active Timer for PSM.

---

**Note** This is related to [3GPP](#) timer T3412.

---

**Note** For NB-IoT, TCP support is dependent on the network. Contact your network provider for details.

---

### Parameter range

0 - 0x35683200 (\* 1 s)

### Default

0x8ca00 (576000 s)

## Command mode options

The following commands are Command mode option commands.

### CC (Command Sequence Character)

The character value the device uses to enter Command mode.

The default value (**0x2B**) is the ASCII code for the plus (+) character. You must enter it three times within the guard time to enter Command mode. To enter Command mode, there is also a required period of silence before and after the command sequence characters of the Command mode sequence (**GT + CC + GT**). The period of silence prevents inadvertently entering Command mode.

#### Parameter range

0 - 0xFF

#### Default

0x2B (the ASCII plus character: +)

### CT (Command Mode Timeout)

Sets or displays the Command mode timeout parameter. If a device does not receive any valid commands within this time period, it returns to Idle mode from Command mode.

#### Parameter range

2 - 0x1770 (x 100 ms)

#### Default

0x64 (10 seconds)

### CN (Exit Command mode)

Immediately exits Command Mode and applies pending changes.

---

**Note** Whether Command mode is exited using the **CN** command or by **CT** timing out, changes are applied upon exit.

---

#### Parameter range

N/A

#### Default

N/A

### GT (Guard Times)

Set the required period of silence before and after the command sequence characters of the Command mode sequence (**GT + CC + GT**). The period of silence prevents inadvertently entering Command mode.

#### Parameter range

0x2 - 0x6D3 (x 1 ms)

**Default**

0x3E8 (one second)

## MicroPython commands

The following commands relate to using MicroPython on the XBee Smart Modem.

### PS (Python Startup)

Sets whether or not the XBee Smart Modem runs the stored Python code at startup.

#### Range

0 - 1

Parameter	Description
0	Do not run stored Python code at startup.
1	Run stored Python code at startup.

#### Default

0

### PY (MicroPython Command)

Interact with the XBee Smart Modem using MicroPython. **PY** is a command with sub-commands. These sub-commands are arguments to **PY**.

#### PYC(Code Report)

You can store compiled code in flash using the **Ctrl-F** command from the MicroPython REPL; refer to the [Digi MicroPython Programming Guide](#). The **PYC** sub-command reports details of the stored code. In Command mode, it returns three lines of text, for example:

---

```
source: 1662 bytes (hash=0xC3B3A813)
bytecode: 619 bytes (hash=0x0900DBCE)
compiled: 2017-05-09T15:49:44
```

---

The messages are:

- **source**: the size of the source code used to generate the bytecode and its 32-bit hash.
- **bytecode**: the size of bytecode stored in flash and its 32-bit hash. A size of **0** indicates that there is no stored code.
- **compiled**: a compilation timestamp. A timestamp of **2000-01-01T00:00:00** indicates that the clock was not set during compilation.

In API mode, **PYC** returns five 32-bit big-endian values:

- source size
- source hash
- bytecode size
- bytecode hash
- timestamp as seconds since 2000-01-01T00:00:00

**PYD (Delete Code)**

**PYD** interrupts any running code, erases any stored code and then does a soft-reboot on the MicroPython subsystem.

**PYV (Version Report)**

Report the MicroPython version.

**PY^ (Interrupt Program)**

Sends **KeyboardInterrupt** to MicroPython. This is useful if there is a runaway MicroPython program and you have filled the stdin buffer. You can enter Command mode (**+++**) and send **ATPY^** to interrupt the program.

**Default**

N/A

## Firmware version/information commands

The following AT commands are firmware version/information commands.

### VR (Firmware Version)

Reads the firmware version on a device.

#### Parameter range

0 - 0xFFFF [read-only]

#### Default

Set in firmware

### VL (Verbose Firmware Version)

Shows detailed version information including the application build date and time.

#### Parameter range

N/A

#### Default

Set in firmware

### HV (Hardware Version)

Read the device's hardware version. Use this command to distinguish between different hardware platforms. The upper byte returns a value that is unique to each device type. The lower byte indicates the hardware revision.

#### Parameter range

0 - 0xFFFF [read-only]

#### Default

Set in firmware

### AI (Association Indication)

Reads the Association status code to monitor association progress. The following table provides the status codes and their meanings.

Status code	Meaning
0x00	Connected to the Internet.
0x22	Registering to cellular network.
0x23	Connecting to the Internet.
0x24	The cellular component is missing, corrupt, or otherwise in error. The cellular component requires a new firmware image.



Status code	Meaning
0x25	Cellular network registration denied.
0x2A	Airplane mode.
0x2B	USB Direct active.
0x2C	Cellular component is in PSM.  <b>Note</b> For NB-IoT, TCP support is dependent on the network. Contact your network provider for details.
0x2F	Bypass mode active.
0xFF	Initializing.

**Parameter range**

0 - 0xFF [read-only]

**Default**

N/A

**HS (Hardware Series)**

Read the device's hardware series number.

**Parameter range**

N/A

**Default**

Set in the firmware

**CK (Configuration CRC)**

Displays the cyclic redundancy check (CRC) of the current AT command configuration settings.

**Parameter range**

0 - 0xFFFFFFFF

**Default**

N/A

## Diagnostic interface commands

The following AT commands are diagnostic interface commands.

### DI (Remote Manager Indicator)

Displays the current Remote Manager status for the XBee.

---

**Note** Digi Remote Manager requires TCP and will not work with NB-IoT, unless the carrier supports TCP.

---

#### Range

Value	Description
0x00	Connected, but without TLS or authentication.
0x01	Before connection to the Internet.
0x02	Remote Manager connection in progress.
0x03	Disconnecting from Remote Manager.
0x04	Not configured for Remote Manager.
0x05	Connected over TLS.
0x06	Connected over TLS with authenticated server.

#### Default

N/A

### CI (Protocol/Connection Indication)

Displays information regarding the last IP connection when using Transparent mode (**AP = 0**).

The following table provides the parameter's meaning when **IP = 0** for UDP connections.

Parameter	Description
0x00	The socket is open.
0x01	Tried to send but could not.
0x02	Invalid parameters (bad IP/host).
0x03	TCP not supported on this cellular component. <hr/> <b>Note</b> For NB-IoT, TCP support is dependent on the network. Contact your network provider for details. <hr/>
0x10	Not registered to the cell network.
0x11	Cellular component not identified yet.

Parameter	Description
0x12	DNS query lookup failure.
0x13	Socket leak
0x20	Bad handle.
0x21	User closed.
0x22	Unknown server - DNS lookup failed.
0x23	Connection lost.
0x24	Unknown.
0xFF	No known status.

The following table provides the parameter's meaning when IP = 1 or 4 for TCP connections.

Parameter	Description
0x00	The socket is open.
0x01	Tried to send but could not.
0x02	Invalid parameters (bad IP/host).
0x03	TCP not supported on this cellular component.
0x10	Not registered to the cell network.
0x11	Cellular component not identified yet.
0x12	DNS query lookup failure.
0x13	Socket leak
0x20	Bad handle.
0x21	User closed.
0x22	No network registration.
0x23	No internet connection.
0x24	No server - timed out on connection.
0x25	Unknown server - DNS lookup failed.
0x26	Connection refused.
0x27	Connection lost.
0x28	Unknown.
0xFF	No known status.

#### Parameter range

0 - 0xFF (read-only)

**Default**

-

**AS (Active scan for network environment data)**

Scans for mobile cells in the vicinity and returns information about the cells in the service area of the device. When you run the command, the cell module waits until all other communication is idle and then performs the scan.

The information that can be reported by this command varies based on the network technology of the module that you are using.

In both AT and API mode the command returns line-based records mapping key-value pairs. The record for the serving cell begins with the capital letter S, and keys for the fields are MCC, MNC, Area, CID, and Signal. Each line describes a particular cell and only those values determined during a single scan are reported.

**Example**

---

```

atas

S MCC:311 MNC:480 Area:48707
CID:48825632 Signal:-88
CID:48825612 Signal:-95
CID:48825603 Signal:-68
CID:48825601 Signal:-71

```

---

**Parameter range**

0-1

Value	Description
0 or no value	Scans for mobile cells in the vicinity and returns information about the cells in the service area of the module. When you run the command, the cell module waits until all other communication is idle and then performs the scan.

**Parameter range**

N/A

**Default**

N/A

## Execution commands

The location where most AT commands set or query register values, execution commands execute an action on the device. Execution commands are executed immediately and do not require changes to be applied.

### NR (Network Reset)

**NR** resets the network layer parameters.

The XBee Smart Modem responds immediately with an **OK** on the UART and then causes a network restart.

If **NR = 0**, the XBee Smart Modem tears down any TCP/UDP sockets and resets Internet connectivity.

You can also send **NR**, which acts like **NR = 0**.

#### Parameter range

0

#### Default

N/A

### !R (Modem Reset)

Forces the cellular component to reboot.



**CAUTION!** This command is for advanced users, and you should only use it if the cellular component becomes completely stuck while in Bypass mode. Normal users should never need to run this command. See the [FR \(Force Reset\)](#) command instead.

---

#### Range

N/A

#### Default

N/A

## File system commands

To access the file system, [Enter Command mode](#) and use the following commands. All commands block the AT command processor until completed and only work from Command mode; they are not valid for API mode or MicroPython's `xbbe.atcmd()` method. Commands are case-insensitive as are file and directory names. Optional parameters are shown in square brackets (`[]`).

**FS** is a command with sub-commands. These sub-commands are arguments to **FS**.

For **FS** commands, you have to type **AT** before the command, for example **ATFS PWD**, **ATFS LS** and so forth.

### Error responses

If a command succeeds it returns information such as the name of the current working directory or a list of files, or **OK** if there is no information to report. If it fails, you see a detailed error message instead of the typical **ERROR** response for a failing AT command. The response is a named error code and a textual description of the error.

---

**Note** The exact content of error messages may change in the future. All errors start with a capital **E**, followed by one or more uppercase letters and digits, a space, and an description of the error. If writing your own AT command parsing code, you can determine if an **FS** command response is an error by checking if the first letter of the response is capital **E**.

---

### ATFS (File System)

When sent without any parameters, **FS** prints a list of supported commands.

#### ATFS PWD

Prints the current working directory, which always starts with `/` and defaults to `/flash` at startup.

#### ATFS CD *directory*

Changes the current working directory to **directory**. Prints the current working directory or an error if unable to change to **directory**.

#### ATFS MD *directory*

Creates the directory **directory**. Prints **OK** if successful or an error if unable to create the requested directory.

#### ATFS LS [*directory*]

Lists files and directories in the specified directory. The **directory** parameter is optional and defaults to a period (`.`), which represents the current directory. The list ends with a blank line.

Entries start with zero or more spaces, followed by filesize or the string **<DIR>** for directories, then a single space character and the name of the entry. Directory names end with a forward slash (`/`) to differentiate them from files. Secure files end with a hash mark (`#`) and you cannot download them.

---

```
<DIR> ./
<DIR> ../
<DIR> cert/
```

---

---

```
<DIR> lib/  
    32 test.txt  
   1234 secure.bin#
```

---

### ATFS PUT *filename*

Starts a YMODEM receive on the XBee Smart Modem, storing the received file to *filename* and ignoring the filename that appears in block 0 of the YMODEM transfer. The XBee Smart Modem sends a prompt (**Receiving file with YMODEM...**) when it is ready to receive, at which point you should initiate a YMODEM send in your terminal emulator.

If the command is incorrect, the reply will be an error as described in [Error responses](#).

### ATFS XPUT *filename*

Similar to the **PUT** command, but stores the file securely on the XBee Smart Modem. See [Secure files](#) for details on what this means.

If the command is incorrect, the reply will be an error as described in [Error responses](#).

### ATFS HASH *filename*

Print a SHA-256 hash of a file to allow for verification against a local copy of the file.

- On Windows, you can generate a SHA-256 hash of a file with the command **certutil -hashfile test.txt SHA256**.
- On Mac and Linux use **shasum -b -a 256 test.txt**.

### ATFS GET *filename*

Starts a YMODEM send of *filename* on the XBee device. When it is ready to send, the XBee Smart Modem sends a prompt: (**Sending file with YMODEM...**). When the prompt is sent, you should initiate a YMODEM receive in your terminal emulator.

If the command is incorrect, the reply will be an error as described in [Error responses](#).

### ATFS MV *source\_path dest\_path*

Moves or renames the selected file or directory *source\_path* to the new name or location *dest\_path*. This command fails with an error if *source\_path* does not exist, or *dest\_path* already exists.

**Note** Unlike a computer's command prompt which moves a file into the *dest\_path* if it is an existing directory, you must specify the full name for *dest\_path*.

---

### ATFS RM *file\_or\_directory*

Removes the file or empty directory specified by *file\_or\_directory*. This command fails with an error if *file\_or\_directory* does not exist, is not empty, refers to the current working directory or one of its parents.

### ATFS INFO

Report on the size of the filesystem, showing bytes in use, available, marked bad and total. The report ends with a blank line, as with most multi-line AT command output. Example output:

---

```
204800 used
695296 free
    0 bad
900096 total
```

---

### **ATFS FORMAT confirm**

Reformats the file system, leaving it with a default directory structure. Pass the word **confirm** as the first parameter to confirm the format. The XBee Smart Modem responds with **Formatting...**, adds a period every second until the format is complete and ends the response with a carriage return.



## BLE commands

The following AT commands are BLE commands.

### BL (Bluetooth MAC address)

The BL command reports the EUI-48 Bluetooth device address (BLE MAC address). Due to standard XBee AT Command processing, leading zeroes are not included in the response when in command mode.

**Parameter range**

N/A

**Default**

N/A

### BT (Bluetooth enable)

The BT command enables or disables the Bluetooth functionality.

**Parameter range**

Bit	Description
0	Bluetooth functionality is disabled.
1	Bluetooth functionality is enabled.

**Default**

### \$\$ (SRP Salt)

**Note** You should only use this command if you have already [configured a password](#) on the XBee device and the salt corresponds to the password.

The SRP (Secure Remote Password) Salt is a 32-bit number used to create an encrypted password for the XBee device. The **\$\$** command is used in conjunction with the **\$V**, **\$W**, **\$X**, and **\$Y** verifiers. Together, the command and the verifiers authenticate the client for the BLE API Service without storing the XBee password on the XBee device.

The salt is configured in the **\$\$** command. In the **\$V**, **\$W**, **\$X**, and **\$Y** verifiers, you specify the 128-byte verifier value, where each command represents 32 bytes of the total 128-byte verifier value.

**Note** XBee device does not allow for 0 to be valid salt. If the value is 0, SRP is disabled and you will not be able to authenticate using Bluetooth.

**Parameter range**

0 - FFFFFFFF

**Default**

0

## **\$V, \$W, \$X, \$Y (SRP password verifier)**

---

**Note** You should only use these commands if you have already [configured a password](#) on the XBee device and the salt verifier values correspond to the password.

---

The **\$V**, **\$W**, **\$X**, and **\$Y** commands are used in conjunction with the **\$S** command used to create an encrypted password for the XBee device. Together with the **\$S** command, these commands authenticate the client for the BLE API Service without storing the XBee password on the XBee device. The salt is configured in the **\$S** command. In the **\$V**, **\$W**, **\$X**, and **\$Y** verifiers, you specify the 128-byte verifier value, where each command represents 32 bytes of the total 128-byte verifier value.

### **Parameter range**

1 - 32 bytes (1-64 hexadecimal characters in command mode)

### **Default**

0

## Remote Manager commands

The following commands are used with Remote Manager.

### DF (Remote Manager Status Check Interval)

Defines the number of minutes between polls for Remote Manager activity.

**Parameter range**

N/A

**Default**

1440

### EQ (Remote Manager FQDN)

Sets or display the fully qualified domain name of the Remote Manager server.

---

**Note** For NB-IoT, TCP support is dependent on the network. Contact your network provider for details.

---

**Range**

From 0 through 63 ASCII characters.

**Default**

**my.devicecloud.com**

### K1 (Remote Manager Server Send Keepalive)

Specify the Remote Manager Server Send Transmit Keepalive Interval value in seconds. The XBee device considers a Remote Manager connection to have failed after 3 missed keepalives.

This command works with the [K2 command](#) to limit data usage. See [Configure Remote Manager keepalive interval](#).

---

**Note** Changing this value causes any currently active Remote Manager connections to be closed and recreated.

---

**Parameter range**

10 - 7200 (x 1 s)

**Default**

75

### K2 (Remote Manager Device Send Keepalive)

Specify the Remote Manager Device Send Transmit Keepalive Interval value in seconds. The Remote Manager considers a connection to have failed after 3 missed keepalives.

This command works with the [K1 command](#) to limit data usage. See [Configure Remote Manager keepalive interval](#).

---

**Note** Changing this value causes any currently active Remote Manager connections to be closed and recreated.

---

**Parameter range**

10 - 7200 (x 1 s)

**Default**

60

**MO (Remote Manager Options)**

Configures the connection to Remote Manager.

---

**Note** When the bit 0 is set to 0, you should manage the Remote Manager keepalive interval, which may otherwise result in excessive data usage. See [Configure Remote Manager keepalive interval](#).

---

**Parameter range**

0 - 7

Bit	Description
0	Maintains a persistent TCP connection to Remote Manager.
1	TCP connection uses TLS. This is the default.
2	Reserved for future use.

**Default**

6 (Bits 1 and 2 are enabled by default.)

**SD (Remote Manager certificate)**

Defines the SSL/TLS Remote Manager certificate.

**Parameter range**

N/A

**Default***/flash/cert/digi-remote-mgr.pem***RI (Remote Manager Service ID)**

Sets the Remote Manager service ID for the XBee.

See [Configure SMS messaging in Remote Manager](#) for more information.**Range**

-

**Default**

idgp

## DP (Remote Manager Phone Number)

Sets the Remote Manager phone number for the XBee device. This code must match the phone number option in the **SMS Configuration** dialog.

See [Configure SMS messaging in Remote Manager](#) for more information.

### Range

-

### Default

32075

## HF (Health Metrics Reporting Frequency)

Reports the time between attempts to upload metrics. The time is measured in minutes. Metrics which cannot be collected or reported at any particular time are skipped until the next attempt.

### Parameter range

N/A

Value	Description
0x3c	One hour.

### Default

0x3c

## HM (Health Metrics)

Sets the Health Metrics to report. This is a bit-mask of values. Each bit set in the mask represents a metric which is reported to Remote Manager.

### Parameter range

N/A

Bit	Description
0	Signal Strength. This is the same value as reported by the <a href="#">DB command</a> in dBm and will be reported to the "metrics/signal_strength" Data Stream in Remote Manager for the devices.

### Default

0x0

## System commands

The following commands are used to assign descriptors to the XBee Smart Modem, which distinguish the devices from each other in Remote Manager.

### KL (Device Location)

Sets or displays a user-defined physical location for the XBee displayed in Remote Manager.

#### Range

Up to 20 ASCII characters

#### Default

One ASCII space character (0x20).

### KP (Device Description)

Sets or displays a user-defined description for the XBee displayed in Remote Manager.

#### Range

Up to 20 ASCII characters

#### Default

One ASCII space character (0x20)

### KC (Contact Information)

Sets or displays user-defined contact information for the XBee displayed in Remote Manager.

#### Range

Up to 20 ASCII characters

#### Default

One ASCII space character (0x20).

## Operate in API mode

---

API mode overview .....	200
Use the AP command to set the operation mode .....	200
API frame format .....	200

## API mode overview

As an alternative to Transparent operating mode, you can use API operating mode. API mode provides a structured interface where data is communicated through the serial interface in organized packets and in a determined order. This enables you to establish complex communication between devices without having to define your own protocol. The API specifies how commands, command responses and device status messages are sent and received from the device using the serial interface or the SPI interface.

We may add new frame types to future versions of firmware, so build the ability to filter out additional API frames with unknown frame types into your software interface.

## Use the AP command to set the operation mode

Use [AP \(API Enable\)](#) to specify the operation mode:

AP command setting	Description
AP = 0	Transparent operating mode, UART serial line replacement with API modes disabled. This is the default option.
AP = 1	API operation.
AP = 2	API operation with escaped characters (only possible on UART).
AP = 3	N/A
AP = 4	MicroPython REPL
AP = 5	Bypass mode. This mode is for direct communication with the underlying chip and is only for advanced users.

The API data frame structure differs depending on what mode you choose.

## API frame format

An API frame consists of the following:

- Start delimiter
- Length
- Frame data
- Checksum

### API operation (AP parameter = 1)

This is the recommended API mode for most applications. The following table shows the data frame structure when you enable this mode:



Frame fields	Byte	Description
Start delimiter	1	0x7E
Length	2 - 3	Most Significant Byte, Least Significant Byte
Frame data	4 - number (n)	API-specific structure
Checksum	n + 1	1 byte

Any data received prior to the start delimiter is silently discarded. If the frame is not received correctly or if the checksum fails, the XBee replies with a radio status frame indicating the reason for the failure.

## API operation with escaped characters (AP parameter = 2)

Setting API to 2 allows escaped control characters in the API frame. Due to its increased complexity, we only recommend this API mode in specific circumstances. API 2 may help improve reliability if the serial interface to the device is unstable or malformed frames are frequently being generated.

When operating in API 2, if an unescaped 0x7E byte is observed, it is treated as the start of a new API frame and all data received prior to this delimiter is silently discarded. For more information on using this API mode, see the [Escaped Characters and API Mode 2](#) in the Digi Knowledge base.

API escaped operating mode works similarly to API mode. The only difference is that when working in API escaped mode, the software must escape any payload bytes that match API frame specific data, such as the start-of-frame byte (0x7E). The following table shows the structure of an API frame with escaped characters:

Frame fields	Byte	Description	
Start delimiter	1	0x7E	
Length	2 - 3	Most Significant Byte, Least Significant Byte	Characters escaped if needed
Frame data	4 - n	API-specific structure	
Checksum	n + 1	1 byte	

### Start delimiter field

This field indicates the beginning of a frame. It is always 0x7E. This allows the device to easily detect a new incoming frame.

### Escaped characters in API frames

If operating in API mode with escaped characters (AP parameter = 2), when sending or receiving a serial data frame, specific data values must be escaped (flagged) so they do not interfere with the data frame sequencing. To escape an interfering data byte, insert 0x7D and follow it with the byte to be escaped (XORed with 0x20).

The following data bytes need to be escaped:

- 0x7E: start delimiter
- 0x7D: escape character

- 0x11: XON
- 0x13: XOFF

To escape a character:

1. Insert 0x7D (escape character).
2. Append it with the byte you want to escape, XORed with 0x20.

In API mode with escaped characters, the length field does not include any escape characters in the frame and the firmware calculates the checksum with non-escaped data.

### Example: escape an API frame

To express the following API non-escaped frame in API operating mode with escaped characters:

Start delimiter	Length	Frame type	Frame Data								Checksum						
			Data														
7E	00 0F	17	01	00	13	A2	00	40	AD	14	2E	FF	FE	02	4E	49	6D

You must escape the 0x13 byte:

1. Insert a 0x7D.
2. XOR byte 0x13 with 0x20:  $13 \oplus 20 = 33$

The following figure shows the resulting frame. Note that the length and checksum are the same as the non-escaped frame.

Start delimiter	Length	Frame type	Frame Data								Checksum							
			Data															
7E	00 0F	17	01	00	7D	33	A2	00	40	AD	14	2E	FF	FE	02	4E	49	6D

The length field has a two-byte value that specifies the number of bytes in the frame data field. It does not include the checksum field.

### Length field

The length field is a two-byte value that specifies the number of bytes contained in the frame data field. It does not include the checksum field.

### Frame data

This field contains the information that a device receives or will transmit. The structure of frame data depends on the purpose of the API frame:

	Length		Frame data									
			Data									
1	2	3	4	5	6	7	8	9	...	n	n+1	
0x7E	MSB	LSB		Data								

- **Frame type** is the API frame type identifier. It determines the type of API frame and indicates how the Data field organizes the information.
- **Data** contains the data itself. This information and its order depend on the what type of frame that the Frame type field defines.

Multi-byte values are sent big-endian.

### Calculate and verify checksums

To calculate the checksum of an API frame:

1. Add all bytes of the packet, except the start delimiter 0x7E and the length (the second and third bytes).
2. Keep only the lowest 8 bits from the result.
3. Subtract this quantity from 0xFF.

To verify the checksum of an API frame:

1. Add all bytes including the checksum; do not include the delimiter and length.
2. If the checksum is correct, the last two digits on the far right of the sum equal 0xFF.

### Example

Consider the following sample data packet: **7E 00 0A 01 01 50 01 00 48 65 6C 6C 6F B8+**

Byte(s)	Description
7E	Start delimiter
00 0A	Length bytes
01	API identifier
01	API frame ID
50 01	Destination address low
00	Option byte
48 65 6C 6C 6F	Data packet
B8	Checksum

To calculate the check sum you add all bytes of the packet, excluding the frame delimiter **7E** and the length (the second and third bytes):

**7E 00 0A 01 01 50 01 00 48 65 6C 6C 6F B8**

Add these hex bytes:

$$01 + 01 + 50 + 01 + 00 + 48 + 65 + 6C + 6C + 6F = 247$$

Now take the result of 0x247 and keep only the lowest 8 bits which in this example is 0xC4 (the two far right digits). Subtract 0x47 from 0xFF and you get 0x3B (0xFF - 0xC4 = 0x3B). 0x3B is the checksum for this data packet.

If an API data packet is composed with an incorrect checksum, the XBee Smart Modem will consider the packet invalid and will ignore the data.

To verify the check sum of an API packet add all bytes including the checksum (do not include the delimiter and length) and if correct, the last two far right digits of the sum will equal FF.

$$01 + 01 + 50 + 01 + 00 + 48 + 65 + 6C + 6C + 6F + B8 = 2FF$$

## API frames

---

The following sections describe the API frames.

AT Command - 0x08 .....	205
AT Command: Queue Parameter Value - 0x09 .....	206
Transmit (TX) SMS - 0x1F .....	207
Transmit (TX) Request: IPv4 - 0x20 .....	208
Tx Request with TLS Profile - 0x23 .....	210
AT Command Response - 0x88 .....	212
Transmit (TX) Status - 0x89 .....	213
Modem Status - 0x8A .....	215
Receive (RX) Packet: SMS - 0x9F .....	216
Receive (RX) Packet: IPv4 - 0xB0 .....	217
User Data Relay - 0x2D .....	218
User Data Relay Output - 0xAD .....	220
BLE Unlock API - 0x2C .....	221
BLE Unlock Response - 0xAC .....	225

## AT Command - 0x08

### Description

Use this frame to query or set parameters on the local device. Changes this frame makes to device parameters take effect after executing the AT command.

### Format

The following table provides the contents of the frame. For details on frame structure, see [API frame format](#).

Field name	Field value	Data type	Description
Frame type	0x08	Byte	
Frame ID		Byte	Identifies the data frame for the host to correlate with a subsequent ACK. If set to <b>0</b> , the device does not send a response.
AT command		Byte	Command name: two ASCII characters that identify the AT command.
Parameter value		Byte	If present, indicates the requested parameter value to set the given register. If no characters are present, it queries the register.

## AT Command: Queue Parameter Value - 0x09

### Description

This frame allows you to query or set device parameters. In contrast to [AT Command - 0x08](#), this frame queues new parameter values and does not apply them until you issue either:

- The AT Command (0x08) frame
- The **AC** command

When querying parameter values, the 0x09 frame behaves identically to the 0x08 frame. The device returns register queries immediately and does not queue them. The response for this command is also an AT Command Response frame (0x88).

### Format

The following table provides the contents of the frame. For details on frame structure, see [API frame format](#).

Field name	Field value	Data type	Description
Frame type	0x09	Byte	
Frame ID		Byte	Identifies the data frame for the host to correlate with a subsequent ACK. If set to <b>0</b> , the device does not send a response.
AT command		Byte	Command name: two ASCII characters that identify the AT command.
Parameter value		Byte	If present, indicates the requested parameter value to set the given register. If no characters are present, it queries the register.

## Transmit (TX) SMS - 0x1F

### Description

Transmit an SMS message. The frame allows international numbers with or without the + prefix. If you omit + and are dialing internationally, you need to include the proper International Dialing Prefix for your calling region, for example, 011 for the United States.

---

**Note** For NB-IoT, SMS support is dependent on the network. Contact your network provider for details.

---

### Format

The following table provides the contents of the frame. For details on frame structure, see [API frame format](#).

Field name	Field value	Data type	Description
Frame type	0x1F	Byte	
Frame ID		Byte	Reference identifier used to match status responses. <b>0</b> disables the TX Status frame.
Options		Byte	Reserved for future use.
Phone number		20 byte string	String representation of phone number terminated with a null (0x0) byte. Use numbers and the + symbol only, no other symbols or letters.
Payload		Variable (160 characters maximum)	Data to send as the body of the SMS message.

## Transmit (TX) Request: IPv4 - 0x20

### Description

A TX Request message causes the device to transmit data in IPv4 format. A TX request frame for a new destination creates a network socket. After the network socket is established, data from the network that is received on the socket is sent out the device's serial port in the form of a Receive (RX) Packet frame.

When you specify protocol **4** (TLS), the profile configuration specified by [\\$0 \(SSL/TLS Profile 0\)](#) is used to form the TLS connection.

---

**Note** For NB-IoT, TCP support is dependent on the network. Contact your network provider for details.

---

### Format

The following table provides the contents of the frame. For details on frame structure, see [API frame format](#).

Field name	Field value	Data type	Description
Frame type	0x20	Byte	
Frame ID		Byte	Reference identifier used to match status responses. <b>0</b> disables the TX Status frame.
Destination address		32-bit big endian	
Destination port		16-bit big endian	
Source port		16-bit big endian	If the source port is <b>0</b> , the device attempts to send the frame data using an existing open socket with a destination that matches the destination address and destination port fields of this frame. If there is no matching socket, then the device attempts to open a new socket. If the source port is non-zero, the device attempts to send the frame data using an existing open socket with a source and destination that matches the source port, destination address, and destination port fields of this frame. If there is no matching socket, the TX Status frame returns an error.
Protocol		Byte	0 = UDP 1 = TCP 4 = SSL/TLS  <b>Note</b> For NB-IoT, TCP support is dependent on the network. Contact your network provider for details.



Field name	Field value	Data type	Description
Transmit options		Byte bitfield	<p>Bit fields are offset 0            Bit field 0 - 7. Bits 0, and 2-7 are reserved, bit 1 is not.            BIT 1 =</p> <p><b>1</b> - Terminate the TCP socket after transmission is complete  <b>0</b> - Leave the socket open. Closed by timeout, see <a href="#">TM (IP Client Connection Timeout)</a>.            Ignore this bit for UDP packets.            All other bits are reserved and should be <b>0</b>.</p>
Payload		Variable	<p>Data to be transferred to the destination, may be up to 1500 bytes.            UDP is limited to 512 bytes.</p>

## Tx Request with TLS Profile - 0x23

### Description

The frame gives greater control to the application over the TLS settings used for a connection.

A TX Request with TLS Profile frame implies the use of TLS and behaves similar to the TX Request (0x20) frame, with the protocol field replaced with a TLS Profile field to choose from the profiles configured with the \$0, \$1, and \$2 configuration commands.

---

**Note** For NB-IoT, TCP support is dependent on the network. Contact your network provider for details.

---

### Format

The following table provides the contents of the frame. For details on frame structure, see [API frame format](#).

Field name	Field value	Data type	Description
Frame type	0x23	Byte	
Frame ID		Byte	Reference identifier used to match status responses. <b>0</b> disables the TX Status frame.
Destination address		32-bit big endian	
Destination port		16-bit big endian	
Source port		16-bit big endian	If the source port is <b>0</b> , the device attempts to send the frame data using an existing open socket with a destination that matches the destination address and destination port fields of this frame. If there is no matching socket, then the device attempts to open a new socket. If the source port is non-zero, the device attempts to send the frame data using an existing open socket with a source and destination that matches the source port, destination address, and destination port fields of this frame. If there is no matching socket, the TX Status frame returns an error.
TLS profile		Byte	Zero-indexed number that indicates the profile as specified by the corresponding <b>\$&lt;num&gt;</b> command.

Field name	Field value	Data type	Description
Transmit options		Byte bitfield	Bit fields are offset 0 Bit field 0 - 7. Bits 0, and 2-7 are reserved, bit 1 is not. BIT 1 = <b>1</b> - Terminate the TCP socket after transmission is complete <b>0</b> - Leave the socket open. Closed by timeout, see <a href="#">TM (IP Client Connection Timeout)</a> . Ignore this bit for UDP packets. All other bits are reserved and should be <b>0</b> .
Payload		Variable	Data to be transferred to the destination, may be up to 1500 bytes.

## AT Command Response - 0x88

### Description

A device sends this frame in response to an AT Command (0x08) frame. Some commands send back multiple frames.

### Format

The following table provides the contents of the frame. For details on frame structure, see [API frame format](#).

Field name	Field value	Data type	Description
Frame type	0x88	Byte	
Frame ID		Byte	Identifies the data frame for the host to correlate with a subsequent ACK. If set to <b>0</b> , the device does not send a response.
AT command		Byte	Command name: two ASCII characters that identify the AT command.
Status	##	Byte	0 = OK 1 = ERROR 2 = Invalid command 3 = Invalid parameter
Parameter value		Byte	Register data in binary format. If the register was set, then this field is not returned.

## Transmit (TX) Status - 0x89

### Description

Indicates the success or failure of a transmit operation.

### Format

The following table provides the contents of the frame. For details on frame structure, see [API frame format](#).

Field name	Field value	Data type	Description
Frame type	0x89	Byte	
Frame ID		Byte	Refers to the frame ID specified in a previous transmit frame
Status		Byte	Status code (see the table below)

The following table shows the status codes.

Code	Description
0x0	Successful transmit
0x21	Failure to transmit to cell network
0x22	Not registered to cell network
0x2c	Invalid frame values (check the phone number)
0x31	Internal error
0x32	Resource error (retry operation later). See <a href="#">Socket limits in API mode</a> for more information.
0x74	Message too long
0x76	Socket closed unexpectedly
0x78	Invalid UDP port
0x79	Invalid TCP port
0x7A	Invalid host address
0x7B	Invalid data mode
0x7C	Invalid interface. See <a href="#">User Data Relay - 0x2D</a> .
0x7D	Interface not accepting frames. See <a href="#">User Data Relay - 0x2D</a> .

Code	Description
0x80	Connection refused
0x81	Socket connection lost
0x82	No server
0x83	Socket closed
0x84	Unknown server
0x85	Unknown error
0x86	Invalid TLS configuration (missing file, and so forth)

## Modem Status - 0x8A

### Description

Cellular component status messages are sent from the device in response to specific conditions.

### Format

The following table provides the contents of the frame. For details on frame structure, see [API frame format](#).

Field name	Field value	Data type	Description
Frame type	0x8A	Byte	
Status	##	Byte	0 = Hardware reset or power up 1 = Watchdog timer reset 2 = Registered with cellular network 3 = Unregistered with cellular network 0x0E = Remote Manager connected 0x0F = Remote Manager disconnected 0x32 = BLE Connect 0x33 = BLE Disconnect 0x34 = Bandmask configuration failed

---

**Note** The BLE Connect and BLE Disconnect events are reported over the UART/SPI interface in API mode when a valid Bluetooth connection has been made and API mode has been unlocked, and also when an unlocked connection disconnects.

---

## Receive (RX) Packet: SMS - 0x9F

### Description

This XBee Smart Modem uses this frame when it receives an SMS message.

---

**Note** For NB-IoT, SMS support is dependent on the network. Contact your network provider for details.

---

### Format

The following table provides the contents of the frame. For details on frame structure, see [API frame format](#).

Field name	Field value	Data type	Description
Frame Type	0x9F	Byte	
Phone number		20 byte string	String representation of the phone number, padded out with null bytes (0x0).
Payload		Variable	Body of the received SMS message.



## Receive (RX) Packet: IPv4 - 0xB0

### Description

The XBee Smart Modem uses this frame when it receives RF data on a network socket that is created by a TX request frame or configuring [C0 \(Source Port\)](#).

---

**Note** For NB-IoT, TCP support is dependent on the network. Contact your network provider for details.

---

### Format

The following table provides the contents of the frame. For details on frame structure, see [API frame format](#).

Frame data fields	Offset	Description
Frame type	3	0xB0
IPv4 32-bit source address	MSB 4	The address in the example below is for a source address of <b>192.168.0.104</b> . 32-bit big endian.
	5	
	6	
	7	
16-bit destination port	MSB 8	The port that the packet was received on. 16-bit big endian.
	LSB 9	
16-bit source port	MSB 10	The port that the packet was sent from. 16-bit big endian.
	LSB 11	
Protocol	MSB 12	0 = UDP 1 = TCP 4 = SSL over TCP
Status	13	Reserved
Payload	14	Data received from the source. The maximum size is 1500 bytes.
	15	
	16	
	17	
	18	

## User Data Relay - 0x2D

### Description

Allows for data to be sent to an interface with a designation of a target interface for the data to be output on. The frame can be sent or received from any of the following interfaces: MicroPython (internal interface), UART, and BLE. This frame is used in conjunction with [User Data Relay Output - 0xAD](#).

You can send and receive User Data Relay Frames from MicroPython. See [Send and receive User Data Relay frames](#) in the *MicroPython Programming Guide*.

### Format

The following table provides the contents of the frame. For details on frame structure, see [API frame format](#).

Field name	Field value	Data type	Description
Frame type	0x2D	Byte	
Frame ID			Reference identifier used to match status responses. <b>0</b> disables the TX Status frame. There is no TX Status frame for success.
Destination interface		Byte	0 = Serial port (SPI, or UART when in API mode) 1 = BLE 2 = MicroPython
Data		Variable	
Checksum		1 Byte	

### Error cases

The Frame ID is used to report error conditions in a method consistent with existing transmit frames. The error codes are mapped to statuses. The following conditions result in an error that is reported in a TX Status frame, referencing the frame ID from the 0x2d request.

- **Invalid interface** (0x7c) : The user specified a destination interface that does not exist.
- **Interface not accepting frames** (0x7d): The destination interface is a valid interface, but is not in a state that can accept data. For example UART not in API mode, BLE does not have a GATT client connected, or buffer queues are full.

### Example use cases

These examples show you can use this frame.

- You can use the frame to send data to an external processor through the XBee UART/SPI via the BLE connection. Use a cellphone to send the frame with UART interface as a target. Data contained within the frame is sent out the UART contained within an Output Frame. The

external processor then receives and acts on the frame.

- Use an external processor to output the frame over the UART with the BLE interface as a target. This outputs the data contained in the frame as the Output Frame over the active BLE connection via indication.
- An external processor outputs the Frame over the UART with the Micropython interface as a target. Micropython operates over the data and publishes the data to mqtt topic.

## User Data Relay Output - 0xAD

### Description

Allows for data to be received on an interface with a designation of the target interface for the data to be output on. The frame can be sent or received from any of the following interfaces: MicroPython (internal interface), UART, and BLE. This frame is used in conjunction with [User Data Relay - 0x2D](#).

### Format

The following table provides the contents of the frame. For details on frame structure, see [API frame format](#).

Field name	Field value	Data type	Description
Delimiter	7E		
Length			
Frame type	0xAD	Byte	
Source interface		1 Byte	
Data		Variable	
Checksum		1 Byte	

## BLE Unlock API - 0x2C

### Description

The XBee Smart Modem uses this frame to authenticate a connection on the Bluetooth interface and unlock the processing of AT command frames. This frame is used in conjunction with the [Response \(0xAC\)](#) frame.

The unlock process is an implementation of the [SRP \(Secure Remote Password\)](#) algorithm using the [RFC5054 1024-bit group](#) and the SHA-256 hash algorithm. The SRP identifying user name, commonly referred to as *I*, is fixed to the value `apiservice`.

Upon completion, each side will have derived a shared session key which is used to communicate in an encrypted fashion with the peer. Additionally, a [Modem Status - 0x8A](#) with the status code 0x32 (Bluetooth Connected) is sent through the UART (if AP=1 or 2). When an unlocked connection is terminated, a Modem Status Frame with the status code 0x33 (Bluetooth Disconnected) is sent through the UART.

The following implementations are known to work with the BLE SRP implementation:

- <https://github.com/cncfanatics/SRP>  
You will need to modify the hashing algorithm to SHA256 and the values of N and g to use the RFC5054 1024-bit group.
- <https://github.com/cocagne/csrp>
- <https://github.com/cocagne/pysrp>

### Format

The following table provides the contents of the frame. For details on frame structure, see [API frame format](#).

Frame data fields	Offset	Description
Frame type	3	0x2C = Request 0xAC = Response

Frame data fields	Offset	Description
Step	4	<p>Indicates the phase of authentication and interpretation of payload data. See</p> <ul style="list-style-type: none"> <li>1 = Client presents <i>A</i> value</li> <li>2 = Server presents <i>B</i> and <i>salt</i></li> <li>3 = Client present <i>M1</i> session key validation value</li> <li>4 = Server presents <i>M2</i> session key validation value and two 12-byte nonces</li> </ul> <p>See the <a href="#">phase tables</a> below for more information.</p> <p>Step values greater than 0x80 indicate error conditions.</p> <ul style="list-style-type: none"> <li>0x80 = Unable to offer <i>B</i> (cryptographic error with content, usually due to <math>A \bmod N \neq 0</math>)</li> <li>0x81 = Incorrect payload length</li> <li>0x82 = Bad proof of key</li> <li>0x83 = Resource allocation error</li> <li>0x84 = Request contained a step not in the correct sequence</li> </ul>
Payload	5	<p>Payload structure varies by Frame ID value. Descriptions are in the tables, below.</p>

The tables below give more information about the phase of authentication and interpretation of payload data.

**Phase 1 (Client presents A)**

If the *A* value is zero, the server will terminate the connection.

Frame data field	Offset in frame	Length
A	5	128 bytes

**Phase 2 (Server presents B and salt)**

Frame data field	Offset in frame	Length
salt	5	4 bytes
B	9	128 bytes

**Phase 3 (Client presents M1)**

Frame data field	Offset in frame	Length
M1	5	Hash algorithm digest length (32 bytes for SHA256)

**Phase 4 (Server presents M2)**

Frame data field	Offset in frame	Length
M2	5	Hash algorithm digest length (32 bytes for SHA256)
TX nonce	37	12-byte (96-bit) random nonce, used as the constant prefix of the counter block for encryption/decryption of data transmitted to the API service by the client
RX nonce	49	12-byte (96-bit) random nonce, used as the constant prefix of the counter block for encryption/decryption of data received by the client from the API service

Upon completion of *M2* verification, the session key has been determined to be correct and the API service is unlocked and will allow additional API frames to be used. Content from this point will be encrypted using AES-256-CTR with the following parameters:

- **Key:** The entire 32-byte session key.
- **Counter:** 128 bits total, prefixed with the appropriate nonce shared during authentication. Initial remaining counter value is 1.

The counter for data sent into the XBee API Service is prefixed with the *TX nonce* value (see the **Phase 4** table, above), and the counter for data sent by the XBee to the client is prefixed with the *RX nonce* value.

**Example sequence to perform AT Command XBee API frames over BLE**

1. Discover the XBee3 device through scanning for advertisements.
2. Create a connection to the GATT Server.
3. Optional, but recommended, request a larger MTU for the GATT connection.
4. Turn on indications for the API Response characteristic.
5. Perform unlock procedure using unlock frames. See [BLE Unlock API - 0x2C](#).

6. Once unlocked, AT Command (0x8) frames may be sent and AT Command Response frames received.
  - a. For each frame to send, form the API Frame, and encrypt through the stream cipher as described in the unlock procedure. See [BLE Unlock API - 0x2C](#).
  - b. Write the frame using one or more Write operations.
  - c. When successful, the response arrives in one or more indications. If your stack does not do it for you, remember to acknowledge each indication as it is received. Note that you are expected to process these indications and the response data is not available if you attempt to perform a read operation to the characteristic.
  - d. Decrypt the stream of content provided through the indications, using the stream cipher as described in the unlock procedure. See [BLE Unlock API - 0x2C](#).



## BLE Unlock Response - 0xAC

### Description

The XBee Smart Modem uses the **BLE Unlock API - 0x2C** frame to authenticate a connection on the Bluetooth interface and unlock the processing of AT command frames. This frame is used in conjunction with the **Response (0xAC)** frame.

For details, see [BLE Unlock API - 0x2C](#).

## Packaged firmware updates

---

You can perform packaged firmware updates on part number XBC-V1-UT-001 (Digi XBee Cellular Verizon LTE Cat 1) modules only.

About packaged firmware updates .....	227
FW Update - 0x2B .....	228
FW Update Response - 0xAB .....	228
Important notes .....	229
Perform a cellular component firmware update .....	229
Error recovery .....	230

## About packaged firmware updates

An XBee Smart Modem contains two processors: a microcontroller that controls most operations of the module, and a cellular component. Both processors contain firmware that you can update. For any given release of the microcontroller firmware (after this referred to as the module firmware), there is an associated release of the cellular component firmware. One or more releases of the module firmware is associated with a given cellular component firmware. However, for a given module firmware, there is only one associated release of the cellular component firmware. The following table depicts an example of this with arbitrary release numbers:

Module firmware	Cellular component firmware
Release 1	Release A
Release 2	Release A
Release 3	Release B
Release 4	Release C
Release 5	Release C
Release 6	Release C
Release 7	Release D

**Note** The module version number keeps incrementing whether or not the cellular component firmware version increases.

### Module firmware update

A module firmware update is the process of updating the firmware on the microcontroller.

### Cellular component firmware update

A cellular component firmware update is the process of updating the firmware on the cellular component.

### Packaged firmware update

A packaged firmware update is the process of updating the firmware on the module and on the cellular component if and only if it is needed. The primary reason for not always updating the cellular component firmware is that it takes 15-20 minutes to complete. A host program that performs packaged firmware updates over the XBee Smart Modem's serial interface is required to know of the association between module firmware and cellular component firmware as shown in [About packaged firmware updates](#).

In addition to knowing which cellular component firmware is required for a given release of the module firmware, the host program needs to know which firmware versions for the module support a cellular component firmware update. For example, if Release 3 is the first version of the module firmware that supports cellular component firmware updates, you must update it before updating the cellular component firmware. But to downgrade from Release 3 or greater to Release 2 or less, you must downgrade the cellular component firmware before downgrading the module firmware. Otherwise, the older firmware would not be able to downgrade the cellular component firmware.

## FW Update - 0x2B

### Description

Use this frame to send Cellular component firmware updates.

### Format

The following table provides the contents of the frame.

Frame data fields	Offset	Type	Description
ID	1	uint8	Will be matched in response. Typically starts at 0, but may start at any number and it must increment with each successive frame (modulo 256).
Component identifier	2	uint8	Set to zero, may be used in the future to identify the target component.
Flags	3	uint8	Bit mask of values indicating various status: bit 0 (0x01) - Initial request. bit 1 (0x02) - Final request (File fully transferred). bit 2 (0x04) - Cancel request (Used to abort an update in progress).
Payload	4	multi-byte	Next section of file being transferred.

## FW Update Response - 0xAB

### Description

This frame is read from the module and it provides the status for each 0x2B frame sent.

### Format

The following table provides the contents of the frame.

Frame data fields	Offset	Type	Description
ID	1	uint8	Value from request payload.

Frame data fields	Offset	Type	Description
Status	2	uint8	Enumeration of status values: 0 - Success >0 - errors <ul style="list-style-type: none"> <li>■ 1 - Operation cancelled</li> <li>■ 2 - Update in progress</li> <li>■ 3 - Update not started</li> <li>■ 4 - Sequence error</li> <li>■ 5 - Internal error</li> <li>■ 6 - Resource error</li> </ul>

## Important notes

Consider the following before performing a cellular component firmware update:

- We recommend using XCTU to update the firmware rather than using the packaged firmware update.



**CAUTION!** Avoid interrupting the process if possible. An interruption requires starting over.

- Packaged firmware update was introduced in version 11412. When updating, you should [Perform a cellular component firmware update](#) after the module firmware is updated.

## Perform a cellular component firmware update

The typical method that we recommend for performing a cellular component firmware update is using XCTU. This topic specifies how a host program can perform a cellular component firmware update without XCTU.

1. Configure the module at a high baud rate: 230,400 (**BD = 8**).
2. Configure the module in API mode (**AP = 1**).
3. Set up the host program to a matching baud rate and API mode.
4. Send the update file.
  - a. Send the first block of the file with **ID** set to **0** and bit 0 of the flags byte set to indicate the first frame. The size of the block does not matter as long as it is less than maximum buffer size (1500 bytes).
  - b. Wait for an ACK before proceeding. An ACK comes in a [FW Update Response - 0xAB](#) with a status of **0**. Under normal conditions, the ACK occurs within 100 ms. However, some responses have been measured to take 80 seconds. To be safe it is best not to timeout on the response for 90 seconds.
  - c. Send all but the last frame of the file with incrementing values for the ID and all bits in the Flags field cleared. Wait for an ACK between each frame sent.
  - d. Send the last block of the file with the next ID and with bit 1 set to indicate last frame. Wait for an ACK on the final case. The final ACK will not arrive until the update has been applied and verified, which can take up to 25 minutes.

After the final ACK is received, the cellular component firmware update is complete.

As a verification, enter [MV \(Modem Firmware Version\)](#) to reveal the version of the cellular component firmware.

---

**Note** The **AI** status must be **0x23** or **0** for **MV** to give a valid response.

---

## Error recovery

Several different types of errors can occur:

### Corrupted firmware on the cellular component

If something goes wrong during a firmware update, (such as a loss of power), there is a good chance that the firmware on the cellular component will be corrupted. This is indicated by an **AI** status of **0x24**. If you see this status, reset the module (using **FR** for example) and then follow the steps in [Perform a cellular component firmware update](#) to redo the cellular component firmware update.

### Error

An error occurs when [FW Update Response - 0xAB](#) returns a non-zero status code. This can be caused by a programming error on the host side (for example out of order sequence numbers), a software error on the module side (for example too short of a timeout waiting for responses from the cellular component), or an invalid image of the cellular component firmware. In any of these cases, the firmware update is aborted such that it cannot be picked up from where it left off. The only reliable recovery is to reset the module and then immediately [Perform a cellular component firmware update](#).

### Host initiated cancellation

If the host sets bit 2 of the flags byte in [FW Update - 0x2B](#), the update in progress is aborted. Recovery is then equivalent to the recovery for negative acknowledgments, described above.

## Troubleshooting

---

This section contains troubleshooting steps for the XBee Smart Modem.

Cannot find the serial port for the device .....	232
Correct a macOS Java error .....	234
Unresponsive cellular component in Bypass mode .....	235
Syntax error at line 1 .....	235
Error Failed to send SMS .....	235
Network connection issues .....	236
Brownout issue .....	236
Hardware flow control in Bypass mode .....	237
Socket leaks .....	237

## Cannot find the serial port for the device

### Condition

In XCTU, the serial port that your device is connected to does not appear.

### Solution

1. Click the **Discover radio modules** button .
2. Select all of the ports to be scanned.
3. Click **Next** and then **Finish**. A dialog notifies you of the devices discovered and their details.

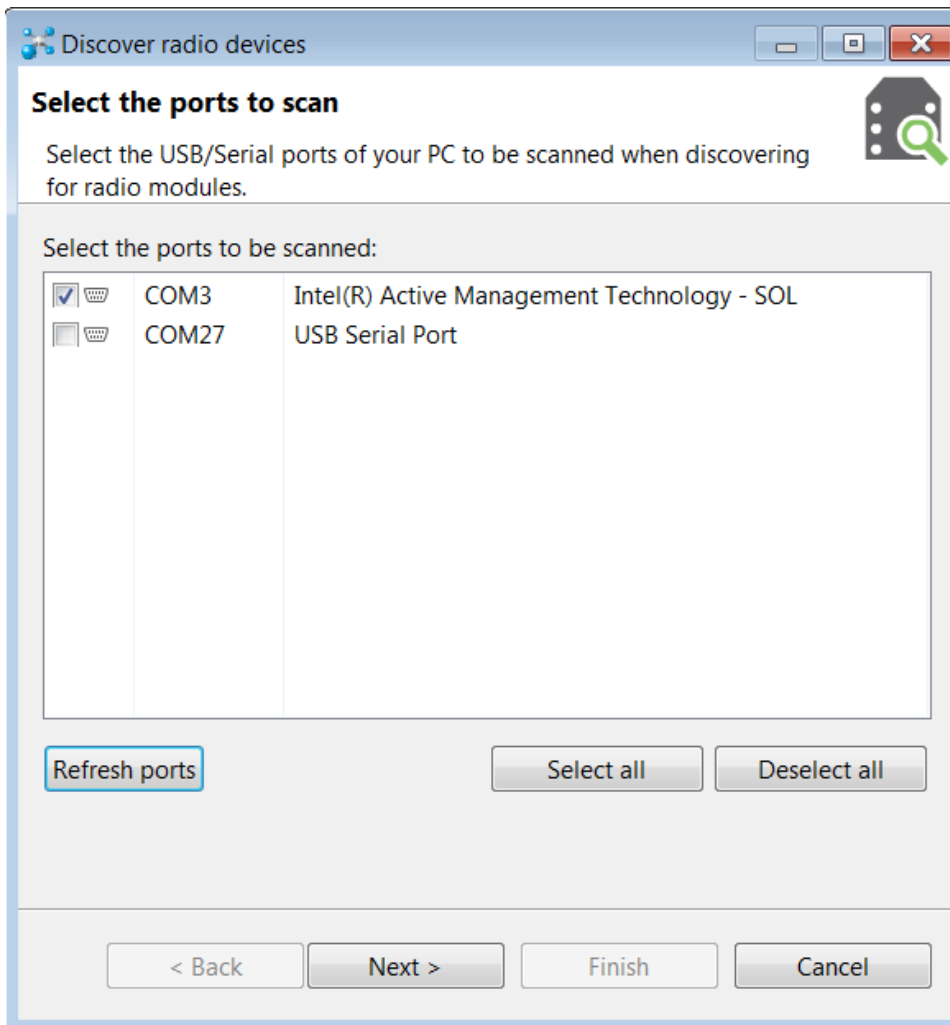

4. Remove the development board from the USB port and view which port name no longer appears in the **Discover radio devices** list of ports. The port name that no longer appears is the correct port for the development board.



## Other possible issues

Other reasons that the XBee Smart Modem is not discoverable include:

1. If you accidentally have the loopback pins jumpered.
2. You may not have a driver installed. If you do not have a driver installed, the item will have an exclamation point icon next to it in the [Windows Device Manager](#).
3. You may not be using an updated FTDI driver.
  - a. Click [here](#) to download the drivers for your operating system.
  - b. This may require you to reboot your computer.
  - c. Disconnect the power and USB from the XBIB-U-DEV board and reconnect it.
4. If you have a driver installed and updated but still have issues, on Windows 10 you may have to enable VCP on the driver; see [Enable Virtual COM port \(VCP\) on the driver](#).

## Enable Virtual COM port (VCP) on the driver

On Windows 10 computers, if XCTU does not see the devices you have attached to a PC, you may need to enable VCP on the USB driver.

To enable VCP:

1. Click the **Search**  button.
2. Type **Device Manager** to search for it.
3. Click **Universal Serial Bus controllers**.
4. If it displays more than one USB controller, unplug the XBee Smart Modem and plug it back in to make sure you choose the correct one.
5. Right-click the USB controller and select **Properties**; a dialog displays.
6. Select the **Advanced** tab.
7. Check **Load VCP**.
8. Click **OK**.
9. Unplug the board and plug it back in.

## Correct a macOS Java error

When you use XCTU on macOS computer, you may encounter a Java error.

### Condition

When opening XCTU for the first time on a macOS computer, you may see the following error:

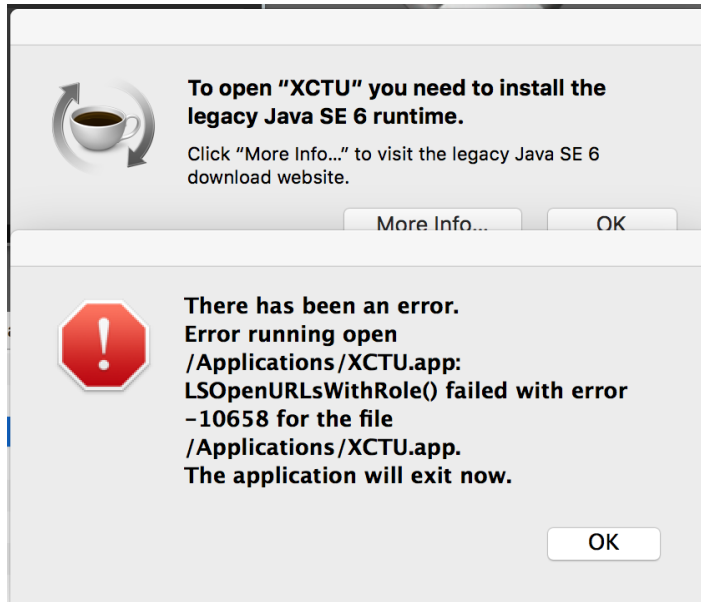

### Solution

1. Click **More info** to open a browser window.
2. Click **Download** to get the file javaforosx.dmg.
3. Double-click on the downloaded javaforosx.dmg.
4. In the dialog, double-click the JavaForOSX.pkg and follow the instructions to install Java.

## Unresponsive cellular component in Bypass mode

When in Bypass mode, the XBee Smart Modem does not automatically reset or reboot the cellular component if it becomes unresponsive.

### Condition

In Bypass mode, the XBee Smart Modem does not respond to commands.

### Solution

1. Query the [AI \(Association Indication\)](#) parameter to determine whether the cellular component is connected to the XBee Smart Modem software. If **AI** is **0x2F**, Bypass mode should work. If not, look at the status codes in [AI \(Association Indication\)](#) for guidance.
2. Ensure that you set [DO \(Device Options\)](#) bit 3 to **0** before entering Bypass mode.
3. You can send the [!R \(Modem Reset\)](#) command to reset only the cellular component.

## Syntax error at line 1

You may get a **syntax error at line 1** error after pasting example MicroPython code and pressing **Ctrl+D**.

### Solution

This commonly happens when you accidentally type a character at the beginning of line 1 before pasting the code.

## Error Failed to send SMS

In MicroPython, you consistently get **Error Failed to send SMS** messages.

---

**Note** For NB-IoT, SMS support is dependent on the network. Contact your network provider for details.

---

### Solution

Your device cannot connect to the cell network. The reason may be:

1. The antenna is improperly or loosely connected.
2. The device is at a location where cellular service cannot reach. If the device is connected to the network, the red LED blinks about twice in a second. If it is not connected it does not blink; see [Associate LED functionality](#).
3. Your SIM card is out of SMS text quota.
4. The device is not getting enough current, for example if power is being supplied only by USB to the XBIB development board, rather than using an additional external power supply.

## Network connection issues

### Condition

The XBee Smart Modem is not joining the network, [AI \(Association Indication\)](#) is cycling between **0xFF** (Initializing), **0x22** (Registering to Cellular Network) and **0x25** (Cellular Network Registration Denied).

### Solution

Some things to check are:

- The antennas are connected correctly to the device.
- The SIM card is seated properly in the device.
- APN is set correctly.
- If you had to change a modem parameter, check to make sure you have reset the module using the [FR command](#) or by pressing the reset button, especially if you have changed settings such as [CP](#), [N#](#), [BM](#), or [BN](#).

---

**Note** The default APN configured in the kit should allow the XBee Smart Modem to get on the network with the SIM included in the kit. However, you may program the APN explicitly to **10569.mcs** if you are having difficulty registering with the network.

---

## Brownout issue

The XBee3 RF Module uses a Silicon Labs EFR32MG System on Chip (SoC). Silicon Labs has announced an intermittent restarting issue with EFR32MG revision B SoCs which can be caused by voltage brownout or supply dips during power-on. The information below is provided to help you avoid this condition.

### Voltage brownout

This issue may occur if the supply powering the XBee VCC pin dips momentarily into the range of approximately 1.2 to 1.8 V. When the supply returns to normal levels the SoC may not restart properly and enter an unresponsive state. You must fully power cycle the XBee to recover from this state. The failure rate tends to increase with slower ramp down rates of the power supply; for more details see [RMU\\_E203 — AVDD Ramp Issue](#). If you keep the power supply within the operational voltage range specified in [Power requirements](#), the conditions to cause this failure are never met.

### Power-on discontinuities

This issue is similar to the voltage brownout issue. The SoC may fail to start if, during power on, the supply powering the VCC pin experiences discontinuities in the voltage rise (in other words, dips) while the voltage is in the range of approximately 1.2 to 1.8 V. You must fully power cycle the XBee Smart Modem to recover from this state. The failure rate tends to increase with slower ramp up rates of the power supply; for more details see [RMU\\_E203 — AVDD Ramp Issue](#). The issue can be avoided by ramping your power supply steadily to the normal operating range.

### How to distinguish revision B parts

Silicon Labs has corrected these issues in revision C of their SoC. We are printing the SoC revision on the XBee label to make it easy to distinguish. The revision letter is located on the bottom right corner

of the product label.

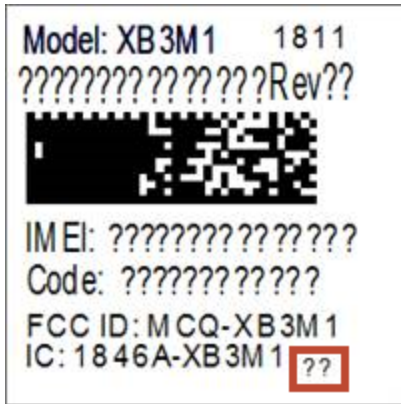

## Hardware flow control in Bypass mode

The lack of hardware flow control support in the u-blox SARA-R410M-02B cellular component may impact the reliability of Bypass mode. Per section 2.5.1 **UART interface** of the SARA-R4 datasheet:

Hardware flow control is not supported by the “00”, “01” and “02” product versions

While the XBee Smart Modem does support hardware flow control on the external UART (pins 2, 3, 12 and 16) the internal UART connection to the cellular component does not. RTS/DIO6 and CTS/DIO7 reflect the flow control state of the device's internal buffers, not the flow control state of the cellular component. This may lead to data loss while in Bypass operating mode during periods of high UART traffic.

The configuration command **BD (Baud Rate)** does not control the baud rate of this internal UART connection. The XBee Smart Modem does not currently have an option to change the baud rate of the internal UART connection to match any changes to the **AT+IPR** setting of the cellular component. We suggest that customers interested in Bypass mode consider using direct USB mode.

## Socket leaks

This applies to devices with the u-blox SARA-R410 cellular component used in the XBee3 Cellular LTE-M Global Smart Modem.

### Condition

There are instances where a socket leaks when closing a connection while there is pending RX data. This state is reported whenever the number of leaked sockets causes an inability to create a new connection.

For Transparent and API modes the XBee Smart Modem returns specific status responses to describe that you need to perform a hard reset to recover the leaked sockets. These statuses are:

Mode	Response
Transparent mode	CI (Protocol/Connection Indication) reports <b>0x13</b> Socket leak

Mode	Response
API mode	Transmit (TX) Status - 0x89 status <b>0x32</b> Resource error (retry operation later)
MicroPython	When attempting to make a connection to a server you receive <b>errno.ENFILE (7023)</b>

### Solution

To recover the leaked sockets and make them available again in all modes, you should perform a reset of the cellular component (hard or soft).

## Regulatory information

---

United States (FCC) .....	240
Innovation, Science and Economic Development Canada (ISED) .....	242
CE mark (Europe) .....	243

## United States (FCC)

XBee Smart Modems comply with Part 15 of the FCC rules and regulations. Compliance with the labeling requirements, FCC notices and antenna usage guidelines is required.

To fulfill FCC Certification, the OEM must comply with the following regulations:

1. The system integrator must ensure that the text on the external label provided with this device is placed on the outside of the final product.
2. RF Modules may only be used with antennas that have been tested and approved for use with the modules.

### OEM labeling requirements

---



**WARNING!** As an Original Equipment Manufacturer (OEM) you must ensure that FCC labeling requirements are met. You must include a clearly visible label on the outside of the final product enclosure that displays the following content:

---

#### ***Required FCC Label for OEM products containing the XBee3 Cellular LTE-M RF Module***

Contains FCC ID: MCQ-XB3M1

Contains FCC ID: XPY2AGQN4NNN

The enclosed device complies with Part 15 of the FCC Rules. Operation is subject to the following two conditions: (i.) this device may not cause harmful interference and (ii.) this device must accept any interference received, including interference that may cause undesired operation.

### FCC notices

**IMPORTANT:** XBee3 RF Modules have been certified by the FCC for use with other products without any further certification (as per FCC section 2.1091). Modifications not expressly approved by Digi could void the user's authority to operate the equipment.

**IMPORTANT:** OEMs must test final product to comply with unintentional radiators (FCC section 15.107 & 15.109) before declaring compliance of their final product to Part 15 of the FCC Rules.

**IMPORTANT:** The RF module has been certified for remote and base radio applications. If the module will be used for portable applications, the device must undergo SAR testing.

This equipment has been tested and found to comply with the limits for a Class B digital device, pursuant to Part 15 of the FCC Rules. These limits are designed to provide reasonable protection against harmful interference in a residential installation. This equipment generates, uses and can radiate radio frequency energy and, if not installed and used in accordance with the instructions, may cause harmful interference to radio communications. However, there is no guarantee that interference will not occur in a particular installation.

If this equipment does cause harmful interference to radio or television reception, which can be determined by turning the equipment off and on, the user is encouraged to try to correct the interference by one or more of the following measures: Re-orient or relocate the receiving antenna, Increase the separation between the equipment and receiver, Connect equipment and receiver to outlets on different circuits, or Consult the dealer or an experienced radio/TV technician for help.



## FCC-approved antennas

The XBee3 RF Module can be installed using antennas and cables constructed with non-standard connectors (RPSMA, RPTNC, and so forth) An adapter cable may be necessary to attach the XBee connector to the antenna connector.

The modules are FCC approved for fixed base station and mobile applications for the channels indicated in the tables below. If the antenna is mounted at least 20 cm from nearby persons, the application is considered a mobile application.

The antennas below have been approved for use with this module. Digi does not carry all of these antenna variants. Contact Digi Sales for available antennas.

### Bluetooth antennas

The following antennas are approved for use with the Bluetooth radio.

Part number	Type (description)	Gain	Application
31000020-02	Integral antenna	-2.5 dBi	Fixed/Mobile
29000095	Dipole (Half-wave articulated RPSMA - 4.5")	2.1 dBi	Fixed/Mobile
A24-HASM-450	Dipole (Half-wave articulated RPSMA-4.5")	2.1 dBi	Fixed/Mobile
A24-HABSM	Dipole (Articulated RPSMA)	2.1 dBi	Fixed
A24-HABUF-P5I	Dipole (Half-wave bulkhead mount U.FL w/ 5" pigtail)	2.1 dBi	Fixed
A24-HASM-525	Dipole (Half-wave articulated RPSMA-5.25")	2.1 dBi	Fixed/Mobile
29000812	Flexible PCB, U.FL w/ 200mm pigtail	4.4 dBi	Fixed/Mobile
FXP74.07.0100A	Flexible PCB, U.FL w/ 100mm pigtail	4.0 dBi	Fixed/Mobile

### Cellular antennas

The gain of the system antenna (i.e. the combined transmission line, connector, cable losses and radiating element gain) must not exceed the values below for mobile and fixed or mobile operating configurations:

- 3.67 dBi in 700 MHz, i.e. LTE FDD-12 band
- 4.10 dBi in 850 MHz, i.e. LTE FDD-5 band
- 6.74 dBi in 1700 MHz, i.e. LTE FDD-4 band
- 7.12 dBi in 1900 MHz, i.e. LTE FDD-2 band

## RF exposure

If you are an integrating the XBee3 RF Module into another product, you must include the following Caution statement in OEM product manuals to alert users of FCC RF exposure compliance:



**CAUTION!** To satisfy FCC RF exposure requirements for mobile transmitting devices, a separation distance of 20 cm or more should be maintained between the antenna of this device and persons during device operation. To ensure compliance, operations at closer than this distance are not recommended. The antenna used for this transmitter must not be co-located in conjunction with any other antenna or transmitter.

## Innovation, Science and Economic Development Canada (ISED)

### Labeling requirements

Labeling requirements for Industry Canada are similar to those of the FCC. A clearly visible label on the outside of the final product enclosure must display the following text.

Contains IC: 1846A-XB3M1

Contains IC: 8595A-2AGQN4NNN

The integrator is responsible for its product to comply with IC ICES-003 & FCC Part 15, Sub. B - Unintentional Radiators. ICES-003 is the same as FCC Part 15 Sub. B and Industry Canada accepts FCC test report or CISPR 22 test report for compliance with ICES-003.

This device complies with Industry Canada licence-exempt RSS standard(s). Operation is subject to the following two conditions: (1) this device may not cause interference, and (2) this device must accept any interference, including interference that may cause undesired operation of the device.

Le présent appareil est conforme aux CNR d'Industrie Canada applicables aux appareils radio exempts de licence. L'exploitation est autorisée aux deux conditions suivantes: (1) l'appareil ne doit pas produire de brouillage, et (2) l'utilisateur de l'appareil doit accepter tout brouillage radioélectrique subi, même si le brouillage est susceptible d'en compromettre le fonctionnement.

### RF Exposure



**CAUTION!** This equipment is approved for mobile and base station transmitting devices only. Antenna(s) used for this transmitter must be installed to provide a separation distance of at least 20 cm from all persons and must not be co-located or operating in conjunction with any other antenna or transmitter.



**ATTENTION!** Cet équipement est approuvé pour la mobile et la station base dispositifs d'émission seulement. Antenne(s) utilisé pour cet émetteur doit être installé pour fournir une distance de séparation d'au moins 20 cm à partir de toutes les personnes et ne doit pas être situé ou fonctionner en conjonction avec tout autre antenne ou émetteur.

### Transmitters with Detachable Antennas

This radio transmitter has been approved by Industry Canada to operate with the antenna types listed in [FCC-approved antennas](#) with the maximum permissible gain and required antenna impedance for each antenna type indicated. Antenna types not included in this list, having a gain greater than the maximum gain indicated for that type, are strictly prohibited for use with this device.

Le présent émetteur radio a été approuvé par Industrie Canada pour fonctionner avec les types d'antenne énumérés ci-dessous et ayant un gain admissible maximal et l'impédance requise pour chaque type d'antenne. Les types d'antenne non inclus dans cette liste, ou dont le gain est supérieur au gain maximal indiqué, sont strictement interdits pour l'exploitation de l'émetteur.

### Detachable Antenna

Under Industry Canada regulations, this radio transmitter may operate using only an antenna of a type and maximum (or lesser) gain approved for the transmitter by Industry Canada. To reduce potential radio interference to other users, the antenna type and its gain should be so chosen that the

equivalent isotropically radiated power (EIRP) is not more than that necessary for successful communication.

Conformément à la réglementation d'Industrie Canada, le présent émetteur radio peut fonctionner avec une antenne d'un type et d'un gain maximal (ou inférieur) approuvé pour l'émetteur par Industrie Canada. Dans le but de réduire les risques de brouillage radioélectrique à l'intention des autres utilisateurs, il faut choisir le type d'antenne et son gain de sorte que la puissance isotrope rayonnée équivalente (p.i.r.e.) ne dépasse pas l'intensité nécessaire à l'établissement d'une communication satisfaisante.

## CE mark (Europe)

The XBee is certified for use in several European countries. For information, visit [www.digi.com/resources/certifications](http://www.digi.com/resources/certifications).

If the XBee is incorporated into a product, the manufacturer must ensure compliance of the final product with articles 3.1a and 3.1b of the RE Directive (Radio Equipment Directive). A Declaration of Conformity must be issued for each of these standards and kept on file as described in the RE Directive (Radio Equipment Directive).

Furthermore, the manufacturer must maintain a copy of the XBee user manual documentation and ensure the final product does not exceed the specified power ratings, antenna specifications, and/or installation requirements as specified in the user manual. If any of these specifications are exceeded in the final product, a submission must be made to a notified body for compliance testing to all required standards.

### OEM labeling requirements

The CE marking must be affixed to a visible location on the OEM product.

### CE labeling requirements

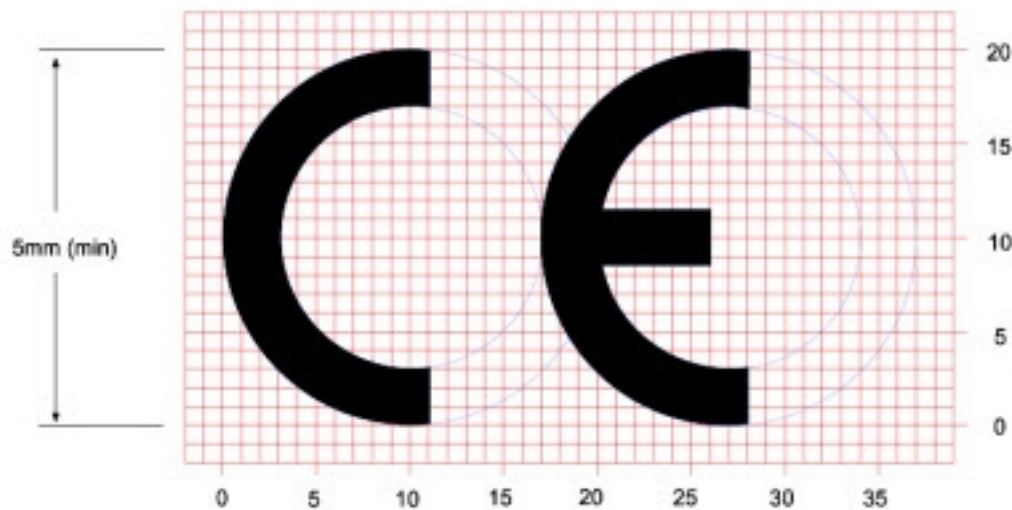

The CE mark shall consist of the initials “CE” taking the following form:

- If the CE marking is reduced or enlarged, the proportions given in the above graduated drawing must be respected.
- The CE marking must have a height of at least 5mm except where this is not possible on

account of the nature of the apparatus.

- The CE marking must be affixed visibly, legibly, and indelibly.